

**DIESEL GENERATOR INSTALLATION
AND OPERATION MANUAL**

UL FILE NUMBER: AU5210

Dear Aksa Generating Set Users:

First of all, we would like to thank you for your choice of an Aksa Generating Set.

It is solid, safe and reliable machine, built according to the latest technology and standards.

This operating and maintenance manual is designed and developed to make you familiar with the generating system.

Please read the following instructions carefully before starting to use your machine.

This manual gives general information about mounting, operation and maintenance of the generating set. Tables and diagrams are also available outlining your generating set.

Never operate, maintain or repair your generating set without taking general safety precautions.

SAVE THESE INSTRUCTIONS-This manual contains important instructions that should be followed during installation and maintenance of the generator and batteries.

Aksa Power Generation USA does not assume responsibility for possible errors.

Aksa Power Generation USA reserves to make changes without prior notice.

DIRECTORY

1. INTRODUCTION.....	3
2. GENERAL SAFETY PRECAUTIONS INSTRUCTIONS.....	5
2.1. General.....	5
2.2. Installation, Handling, and Towing.....	5
2.3. Fire and Explosion.....	6
2.4. Mechanical.....	7
2.5. Chemical.....	7
2.6. Noise.....	8
2.7. Electrical.....	8
2.8 First Aid For Electric Shock.....	8
2.9. Recovery Position.....	10
3. GENERAL DECRPTION.....	11
3.1. Generating Set Description and Identification.....	11
3.2. Generating Set Main Parts.....	12
3.3. Diesel Engine.....	13
3.4. Engine Electrical System.....	13
3.5. Cooling System.....	14
3.6. Synchronous Alternator.....	14
3.7. Coupling.....	14
3.8. Fuel tank and Base frame.....	14
3.9. Vibration Isolation.....	14
3.10.Silencer and Exhaust system.....	14
3.11. Control System.....	15
3.12 Field Wiring.....	15
4. INSTALLATION, HANDLING AND STORAGE.....	20
4.1 General.....	20
4.2 Canopies.....	20
4.3 Moving the Generating Set.....	20
4.4. Location.....	21
4.5. Base and Foundation.....	21
4.6. Room Design Guidance Notes.....	23
5. FUEL SYSTEM.....	27
5.1. General.....	27
5.2. Diesel Fuel Recommendations.....	27
5.3. Base Fuel Tank.....	28
5.4. Bulk Storage Tanks.....	28
5.5. Without Intermediate Fuel Tank (Fig.5.1.).....	29
5.6. With Intermediate Fuel Tank(Fig.5.2).....	29
5.7. Daily Service Fuel Tank.....	30
5.8. Determining Pipe Sizes.....	30
5.9. Fuel Return Lines.....	31
6. COOLANT TREATMENT.....	33

6.1. General.....	33
6.2. Engine Coolant	33
6.3. Engine Warming	33
7. EXHAUST SYSTEM.....	34
7.1. Sizing.....	34
7.2. Routing	32
8. LUBRICATING OIL.....	36
8.1. Oil Performance Properties	36
8.2. Lubrication Recommendations for Engine	36
9. ELECTRIC STARTING SYSTEMS.....	39
9.1. Battery Systems	39
9.2. Maintenance Batteries	39
9.3. Battery Maintenance	39
9.4. Maintenance Free Batteries	40
9.5. Starting Aids.....	40
9.6. Cold Cranking Ampere Rating of the Battery	40
9.7. Battery Connection.....	40
10. ELECTRICAL CONNECTION	41
10.1. Cabling	41
10.2. Protection	41
10.3. Loading.....	41
10.4. Power Factor.....	42
10.5. Grounding/Earthing Requirements.....	42
10.6. Insulation Test:.....	42
10.7 Fuse ratings and instructions.....	42
11. ACOUSTIC SILENCING.....	46
11.1. Exhaust Silencers:	46
11.2. Canopies	46
11.3. Other Sound Attenuation:.....	46
12. STORAGE.....	47
12.1. Engine Storage:	47
12.2. Alternator Storage:	47
12.3. Battery Storage:	47
13. GENERAL PRECAUTIONS AND CONTROLS WHICH MUST BE DONE BEFORE STARTING UP THE GENERATING SET	48
14. GENERATING SET CONTROL SYSTEMS.....	49
14.1. DSE7320, Control System with Automatic Mains Failure.....	49
15. GENERAL PRECAUTIONS AND CONTROLS WHICH MUST BE DONE AFTER STARTING UP THE GENERATING SET	56
16. CONTROL PANELS	57
17. THE PLACEMENT AND INSTALLATION OF AUTOMATIC TRANSFER SWITCH (ATS).....	59
18. ENGINE TROUBLESHOOTING.....	60
19. GENERAL PRECAUTIONS ABOUT WARRANTY	63
20. ELECTRICAL WIRING DIAGRAMS.....	64

1. INTRODUCTION

**SAVE THESE INSTRUCTIONS
THESE INSTRUCTIONS ARE IMPORTANT**

This operations and maintenance manual has been prepared to assist the operator with the proper operation and maintenance of the generating set. Observing the suggestions and rules in this manual will ensure that the generating set operates at maximum performance and efficiency throughout the life of the unit.

Required maintenance should be performed more frequent in dirty and dusty environments in order to keep the generating set in good working condition.

Each generating set indicates the model and serial numbers on the base frame. Also, each set has a data plate (See Below) indicating the manufacture date, voltage, current, power in kVA, frequency, power factor, and weight of the generating set.

This information will be necessary for spare part orders, warranty validity, and service calls.

AKSA Power Generation USA				371 Exchange Street, West Monroe, LA 71292					
				Tel: 318 855 8377		Fax: 318 855 8381			
				sales@aksausa.com		www.aksausa.com			
Model				Product Date					
Prime Power				Standby Power					
Prime A				Standby A					
Alternator Model				Serial Number					
Dimensions				Alternator Serial No.					
Weight				Engine Family Name					
Volts				List Number					
Phase Connection									
Rated Ambient Temperature				File Number	AU5210				
Insulation System Class				Control Number	4SV1				
	Hz		pf	Unbalanced Capability	25%				
	Phase		r.p.m.	AKSA 1	✓				

Figure 1.1

The generating set is designed to be safe when used properly. However, responsibility for safety rests with the personnel who install, use, and maintain the set. If the following safety precautions are followed, the possibility of an accident is minimized. Before performing any procedure or operating technique, it is up to the user to ensure that it is safe. The generating set should only be operated by personnel who are authorized and trained.

Only people that have been properly trained should be allowed to operate, adjust, perform maintenance, or make repairs on Aksa Power Generation equipment. It is the responsibility of the purchaser to appoint operators with the appropriate training and skill for each job category.

Skill level 1: Operator

An operator that is trained in all aspects of operating the unit with the push buttons and is also trained to know the safety aspects.

Skill level 2: Mechanical technician

A mechanical technician is trained to operate the unit with the same proficiency as the operator. The mechanical technician is also trained to perform maintenance and repair as described in the operation manual. A mechanical technician is allowed to change the settings of the controls and safety system. A mechanical technician does not work on live electrical components.

Skill level 3: Electrical technician

An electrical technician and has the same qualifications as both the operator and the mechanical technician. The electrical technician may also carry out electrical repairs within the various enclosures of the unit. This includes work on live electrical components.

Skill level 4: Specialist from the manufacturer

This is a skilled specialist sent by the manufacturer or its agent to perform complex repairs or modifications to the equipment. It is recommended that not more than two people operate the unit; more operators could lead to unsafe operating conditions. Take necessary steps to keep all unauthorized personnel away from the unit to eliminate all possible source of danger at the unit.

The manufacturer does not accept any liability for damages caused by the use of non-original parts, Modifications, additions, or conversions made without the manufacturer's approval in writing.

The stationary engine generator assembly is to be installed over noncombustible materials and shall be located in such a manner that shall prevent combustible materials from accumulating under the generator set.

2. GENERAL SAFETY PRECAUTIONS INSTRUCTIONS

2.1. General

1. The owner is responsible for maintaining the unit in a safe operating condition. Unit parts and accessories must be replaced if missing or unsuitable for safe operation.
2. Only operate this unit for its intended purpose and within its rated limits (pressure, temperature, speeds, etc.).
3. Gen-set and equipment shall be kept clean, i.e. as free as possible from oil, dust or other deposits.
4. To prevent an increase in operating temperature, inspect and clean heat transfer surfaces (cooler fins, intercoolers, water jackets, etc.) regularly.
5. Handle all substances with care. Keep spill containment supplies nearby in case of spills in order to prevent environmental hazards. Fuel and oil are flammable and should be kept away from any sources of ignition; the proper fire extinguisher should be kept nearby in case of fire.

WARNING

! Read and understand all safety precautions and warnings before operating or performing maintenance on the generating set.

! Failure to follow the instructions, procedures, and safety precautions in this manual may increase the possibility of accidents and injuries.

! Do not attempt to operate the generating set if any unsafe condition is known.

! If the generating set is unsafe, put danger notices and disconnect the battery negative (-) lead so that it cannot be started until the condition is corrected.

! Disconnect the battery negative (-) lead prior to attempting any repairs or cleaning inside the enclosure.

! Install and operate this generating set only in full compliance with relevant National, Local or Federal Codes, Standards or other requirements.

2.2. Installation, Handling, and Towing

Chapter 4 and 12 of this manual cover the procedures for installation, handling and towing of generating sets. These chapters should be read before installing, moving and/or lifting the generating set or towing a mobile set. The following safety precautions should be noted:

WARNING

! Make electrical connections in compliance with relevant Electrical Codes, Standards or other requirements. This includes requirements for grounding and ground/earth faults.

! For stationary generating sets with remote fuel storage systems, make sure such systems are installed in compliance with relevant Codes, Standards or other requirements.

! Engine exhaust emissions are hazardous to personnel. The engine exhaust for all indoor generating sets must be piped

outdoors via leak-free piping in compliance with relevant Codes, Standards and other requirements. Ensure that hot exhaust silencers and piping are clear of combustible material and are guarded for personnel protection per safety requirements. Ensure that fumes from the exhaust outlet will not be a hazard.

! Never lift the generating set by attaching to the engine or alternator lifting lugs, instead use the lifting points on the base frame or canopy.

! Ensure that the lifting rigging and supporting structure is in good condition and has a capacity suitable for the load.

! Keep all personnel away from the generating set when it is suspended.

2.3. Fire and Explosion

Fuel and fumes associated with generating sets can be flammable and potentially explosive. Proper care in handling these materials can dramatically limit the risk of fire or explosion. However, safety dictates that fully charged BC and ABC fire extinguishers are kept on hand. Personnel must know the specific uses for each one and how to operate them.

WARNING

! Ensure that the generating set room is properly ventilated.

! Keep the room, the floor and the generating set clean. When spills of fuel, oil, battery electrolyte or coolant occur, they should be cleaned up immediately.

! Never store flammable liquids near the engine.

! Do not smoke or allow sparks, flames, or other sources of ignition around fuel or batteries.

! Fuel vapors are explosive. Hydrogen gas generated by charging batteries is also explosive.

! Never store flammable liquids near the engine.

! Do not smoke or allow sparks, flames, or other sources of ignition around fuel or batteries. Fuel vapors are explosive.

Hydrogen gas generated by charging batteries is also explosive.

! Turn off or disconnect the power to the battery charger before making or breaking connections with the battery.

! To avoid arcing keep grounded conductive objects (such as tools) away from exposed live electrical parts (such as terminals). Sparks and arcing might ignite fuel or vapors.

! Avoid refilling the fuel tank while the engine is running.

! Do not attempt to operate the generating set with any known leaks in the fuel system.

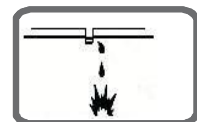

2.4. Mechanical

The generating set is designed with guards for protection from moving parts. Care must still be taken to protect personnel and equipment from other mechanical hazards when working around the generating set.

WARNING

! Do not attempt to operate the generating set with the safety guards removed. While the generating set is running do not attempt to reach under or around the guards to do maintenance or for any other reason.

! Keep hands, arms, long hair, loose clothing and jewelers away from pulleys, belts and other moving parts.



Attention: Some moving parts cannot be seen clearly when the set is running.

! Keep access doors on enclosures closed and locked when not required to be open if equipped.

! Avoid contact with hot oil, hot coolant, hot exhaust gases, hot surfaces, sharp edges, and sharp corners.



! Wear protective clothing including gloves and hat when working around the generating set.

! Do not remove the radiator filler cap until the coolant has cooled. After cooling has taken place, loosen the cap slowly to relieve any excess pressure before removing the cap completely.



2.5. Chemical

Fuels, oils, coolants, lubricants, and the battery electrolyte used in this generating set are typical of the industry. However, they can be hazardous to personnel if not treated properly.

WARNING

! Do not swallow or allow skin contact with fuel, oil, coolant, lubricants, or the battery electrolyte. If swallowed, seek medical treatment immediately. Do not induce vomiting if fuel is swallowed. For skin contact, wash with soap and water.

! Do not wear clothing that has been contaminated by fuel or lube oil.

! Wear an acid resistant apron and face shield or goggles when servicing the battery.

! If any electrolyte gets on skin or clothing flush immediately with large quantities of water.



2.6. Noise

Generating sets that are not equipped with sound attenuating enclosures can produce noise Levels in excess of 105 dB(A). Prolonged exposure to noise levels above 85 dB(A) is hazardous to hearing.



WARNING

Ear protection must be worn at all times when operating or working around an operating generating set.

2.7. Electrical

Safe and efficient operation of electrical equipment can be achieved only if the equipment is correctly installed, operated, and maintained.

WARNING

! The generating set must be connected to the load only by trained and qualified electricians who are authorized to do so. Connections must be made in compliance with relevant Electrical Codes, Standards and other regulations.

! Ensure that the generating set is effectively grounded in accordance to all relevant regulations prior to operation.

! The generating set should be shut down with the battery negative (-) terminal disconnected prior to attempting to connect or disconnect load connections.

! Do not touch electrically energized parts of the generating set and/or interconnecting cables or conductors with any part of the body or with any non-insulated conductive object.

! Replace the generating set terminal box cover as soon as connection or disconnection of the load cables is complete. Do not operate the generating set without the cover securely in place.

! Connect the generating set only to loads and/ or electrical systems that are compatible with its electrical characteristics and that are within its rated capacity.

! Keep all electrical equipment clean and dry. Replace any wiring where the insulation is cracked, cut, abraded or damaged in any other way. Replace terminals that are worn, discolored or corroded. Keep terminals clean and tight.

! Insulate all connections and disconnected wires.

! Use only Class BC or Class ABC extinguishers on electrical fires.

! Caution: risk of electric shock, the grounded conductor must be bonded to ground in accordance with the National Electric Code NFPA 70. this unit shall not be used in floating output applications.

! Notice: isolated neutral not bonded to frame.



warning:
High voltage

2.8 First Aid for Electric Shock

! Do not touch the victim's skin with bare hands until the source of electricity has been turned off.

! If possible, switch the power off. Otherwise, pull the plug or cable away from the victim by its insulation or by using some other insulated device.

! If this is not possible, stand on any dry insulating material such as dry wood and pull the victim clear of the conductor.

! If the victim is breathing, turn the victim clear of the conductor, preferably using insulated material such as dry wood.

! If victim is breathing, turn the victim into the recovery position described below. If victim is unconscious, perform resuscitation as required:

Open the airway

Tilt the victim's head back and lift the chin upwards.

Remove objects from the mouth or throat (including false teeth, tobacco or chewing gum).



Breathing

Check that the victim is breathing by looking, listening and feeling for the breath.



Circulation

Check for pulse in the victim's neck.



If victim is not breathing, but pulse is present:

- Pinch the victim's nose firmly.
- Take a deep breath and seal your lips around the victim's lips.
- Blow slowly into the mouth watching for the chest to rise.
- Let the chest fall completely. Give breaths at a rate of 10 per minute.
- If the victim must be left to get help, give 10 breaths first and then return quickly and continue.
- Check for pulse after every 10 breaths. When breathing restarts, place the victim into the recovery position described later in this section.

If victim is not breathing and no pulse can be found:

- Call or telephone for medical help.
- Give two breaths and start chest compression as follows:
- Place heel of hand/2 fingers. Place above ribcage/breastbone junction.
- Place other hand on top and interlock fingers.
- Keeping arms straight, press down 4-5 cm at a rate of 15 times per minute.
- Repeat cycle (2 breaths and 15 compressions) until medical helps takes over.
- If condition improves, confirm pulse and continue with breaths.
- Check for pulse after every 10 breaths.
- When breathing restarts, place the victim into the recovery position described below.



2.9. Recovery Position

- Turn the victim onto the side.
- Keep the head tilted with the jaw forward to maintain the open airway.
- Make sure the victim cannot roll forwards or backwards.
- Check for breathing and pulse regularly. If either stops, proceed as above.



WARNING

! Do not give liquids until victim is conscious.

3. GENERAL DESCRIPTION

3.1. rating Set Description and Identification

Diesel-electric generating sets are independent units for the production of electric power comprised of a constant voltage synchronous generator driven by an internal-combustion, diesel-cycle engine.

The sets are used for two main purposes:

A-Continuous duty sets,

These are used to produce electric power for countless requirements (lighting, heating, etc.) in areas where other sources or power are unavailable.

B- Emergency duty sets,

These are used in such instances where public utility failures are liable to cause damage to lives, to materials, to finances, (i.e. hospitals, industrial plants with non-stop operating cycles, etc.) or to meet peak energy demands.

According to their application, the sets are further divided into:

- set for use on land
- set for use at sea

The sets for use on land can be either:

- stationary sets (fixed installation), or
- mobile sets (mobile installation)

These two types of sets are available in a vast range of versions for every operating requirement with the main ones being:

- hand control generating sets
- stand-by generating sets

The standard stationary generating set comprises:

- diesel engine
- synchronous generator
- coupling
- metal sub-base with vibration isolators
- starter batteries
- fuel tank within the bed-plate
- instrument panel
- exhaust gas silencer.

The normal temperature range for the operation of this genset is 5° F—104° F. If the temperature drops below 23° F, a heater may be required to aid start.

This Aksa Generating Set has been designed as a complete package to provide superior performance and reliability. Figure 3.1 shows a typical generating set with major components labeled. However, each set will be slightly different due to the size and configuration of the major components. This section briefly describes the parts of the generating set. Further information is provided in later sections of this manual.

Each generating set is provided with a Rating Label (Item 1) generally fixed to the base frame. This label contains the information needed to identify the generating set and its operating characteristics. This information includes the model number, serial number, output characteristics such as voltage and frequency, output rating in kVA and kW, product date and weight.

The model and serial numbers uniquely identify the generating set and are needed when ordering spare parts or obtaining service or warranty work for the set. AC series generating sets are an Alternating Current generators, built for continuous operating at sites where no electricity is available (some models are excepted) or as stand-by in case of interruption of the main utility power.

The generator operates at 208/120 V in line-to-neutral mode and 277/480 V in line-to-line mode. The AC series generating set is driven by a water-cooled diesel engine.

NOMENCLATURE
 BREAKDOWN:
 EXAMPLE (Three phase Gen-set) 8-10 symbol model designation APD-U LP611
 1st -3rd –model series
 4th -5th symbols “UL”
 6th - (optional) Engine Type
 P-Perkins
 J- John deer
 M- Mitsubishi
 7th -10th –KW ratings
 (9,13,20,28,30,40,55,65,80,82,100,125,150,178,180,200,250,275,300,350,400,461,500,512,585,511,800,1000,1250,1600,2000)

EXAMPLE (single phase Gen-set) 8-10 symbol model designation APD-U LP100
 1st -3rd –model series
 4th -5th symbols “UL”
 6th - (optional) Engine Type
 P-Perkins
 7th -9th –KW ratings
 (10,13,20,28,30,58,65,82,100,150)
 10th -phase

3.2. Generating Set Main Parts



Figure 3.1 Typical generating set configuration

No	Description
1	Aksa generating set rating label
2	Diesel engine
3	Air filter
4	Battery
5	Battery charging alternator
6	Radiator
7	Alternator
8	Terminal box
9	Base frame
10	Fuel tank (inside the base frame)
11	Vibration isolators
12	Control Panel

Table 3.1

3.3. Diesel Engine

The diesel engine powering the generating set (Item 2) has been chosen for its reliability and the fact that it has been specifically designed for powering generating sets.

It has a heavy duty, industrial engine with a four-stroke compression ignition system.

It has been fitted with all accessories necessary to provide a reliable power supply. These accessories include, among others, a cartridge type dry-air filter (item 3) and either a mechanical or an electronic engine speed governor. The engine cylinder block is one piece cast iron, vertical cylinders with inline overhead valves, and camshaft in block or V- type, according to the type.

The thermally loaded flame plate is efficiently water cooled. The crankshaft is forged in one piece of high tensile steel.

Lubrication: forced lubrication via gear pump, special paper cartridge -type filters, lubricant cooling via heat exchanger on most versions.

3.4. Engine Electrical System

The engine electrical system is 12 volt or 24 volts DC, negative ground/earth. This system includes an electric engine starter, a battery (item 4) and a battery charging alternator (item 5). For 12 volts electrical system one battery is given. For 24-volt system two lead-acid batteries are given. Other types of batteries may be fitted if they were specified.

3.5. Cooling System

The engine cooling system is water cooled. The water cooled system is comprised of a radiator (item 6) a pusher fan and thermostat. The alternator has its own internal fan to cool its components.

3.6. Synchronous Alternator

This is a horizontal axle alternator (synchronous three phase), on rolling bearings, It is self-ventilated within the room with low-loss silicon-sheet stator bundle, and an electrolytic copper winding with class H insulation.

The output electrical power is normally produced by a screen protected, drip-proof, self-exciting, self-regulating, brushless alternator. (Item 7) Which is fine tuned to the output of this generating set. Mounted on top of the alternator is a sheet steel terminal box (item 8). Normally, the voltage imbalance capability is 1%, but if generator operation needs to be synchronous, this data should be reduced to 0.5%.

3.7. Coupling

Engine and alternator are firmly joined by a coupling cone that guarantees the proper assembly. If Mono-support machines are used, a special flexible disk is used in place of a flexible coupling.

3.8. Fuel Tank and Base Frame

The engine and alternator are coupled together and mounted on a heavy duty steel base-frame (Item 9). This base frame includes a fuel tank (Item 10) with capacity of approximately 8 hours operation under variable loads. The tank is complete with filling cap and fuel level gauge, and it is connected, by flexible joints, to the intake piping and to the overflow piping containing fuel from the injector drain. High power gen-set's fuel tank is separate from gen-set. State: If the base frame have an open bottom, the stationary engine generator assembly shall be installed over noncombustible materials and shall be located such that it prevents combustible materials from accumulating under the generator set.

3.9. Vibration Isolation

The generating set is fitted with vibration isolators (Item 11) which are designed to reduce engine vibration being transmitted to the foundation on which the generating set is mounted. These isolators are fitted between the engine /alternator feet and the base frame.

3.10. Silencer and Exhaust system

Exhaust gases from the turbocharger are discharged toward atmosphere through a silencer. These should be vented as high as possible to prevent them from re-entering the engine via the charge air intake and polluting the radiator fins.

It is important to note that the turbocharger nozzles must always be free of loads. A stainless steel exhaust compensator is

delivered with generator set. Exhaust lines of different engines shall not be mixed in a common stack, but should be routed separately in individual ducts and be enclosed within a chimney.

Suitable material is carbon steel sheet, and recommended calculation temperature is 977°F. A permanent means of drainage for rain and condensate shall be provided to prevent water from entering the silencer or the engine. An exhaust silencer is provided, shipped loosely, for installation with the generating set. The silencer and exhaust system significantly reduces the amount of noise emitted by the engine and directs exhaust gases through safe outlets.

The exhaust silencer is made of a carbon steel receiver and contains a sound attenuator and wave de-phasing system made of perforated steel sheet and heavy rock wool. It is asbestos-free. The exhaust silencer is delivered in two configurations with one being industrial attenuation and the other being critical attenuation.

3.11. Control System

One of several types of control systems and panels (item 12) may be fitted to control the operation and output of the set and also protect the set from possible malfunctions. Section 15 of this manual provides detailed information on these systems and will aid in the identification of the control system fitted on the generating set.

3.12 Field Wiring

It is the customer's responsibility to provide cables with terminals to connect the genset and the loads. Terminal uses standard JG copper connections, and the terminal size is chosen according to cable size (Terminals are listed in Table 10.2 below). When connecting the load cables, a torque wrench should be used to tighten the Grade 5 bolts for each phase. Torque requirements can be found in Table 3.2. In most situations, the bus bar panel (breaker) will be mounted to the base frame. There is an access hole which can be utilized for making connections. See picture below.



Figure 3.2 Gen-set field wiring of load cables

- 1 Load cables connecting terminal of gen-set;
- 2 Load cables can be connected with gen-set through these Knock down holes;
- 3 Grounding terminal (UL listed KDER, installation tool: 1/14" hex wrench)

The customer should also connect the ground as shown in Figure 3.3 below using a UL Listed (KDER) terminal.

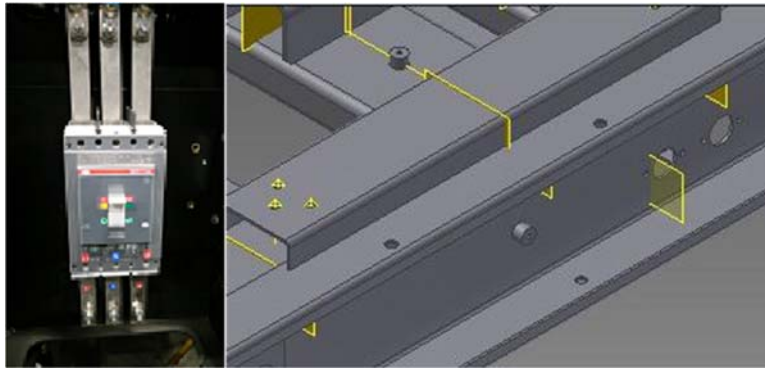

Figure 3.3 Grounding terminal

BOLT SIZE	TIGHTENING TORQUE		
	8.8 rank	10.9 rank	12.9 rank
M10	36.1 ft·lb	53.1 ft·lb	62.0 ft·lb
M12	63.4 ft·lb	92.9 ft·lb	106.9 ft·lb

Table 3.2

See attached Table 310.16 below in the NEC to properly size field conductors. The proper UL listed terminals for all terminations should be selected by determining suitability for the required application.

NEC 2011 Table 310.15(B)(16) Allowable Ampacities of insulated Conductors Rated Up to and Including 2000 Volts, 60 Through 90°C (140 Through 194°F), Not More Than The Conductors in Raceway, Cable or Earth (Directly Buried), Based on Ambient Temperature of 30°C (86°F)			
Size AWG or kcmil	Temperature Rating of Conductor [See NEC Table 310.104(A)]		
	60°C (140°F)	75°C (167°F)	90°C (194°F)
	Type TW, UF	Types: RHW THHW THW THWN XWWH	Types: TBS, SA, SIS, FEP FEPB MI, RHH, RHW-2, THHN THHW, THW-2, THWN-2, USE-2, XHH, XHHW, XHHW-2, ZW-2
COPPER			
18	14
16	20
14**	15	20	28
12**	20	25	38
10**	30	35	47
8	40	50	60
6	55	65	80
4	70	85	100
3	85	100	125
2	95	115	140
1	110	130	165
1/0	125	150	180
2/0	145	175	230
3/0	165	200	280
4/0	195	230	325
250	215	255	375
300	240	285	430
350	260	310	450
400	280	335	495
500	320	380	530
600	350	420	610
700	385	460	630
750	400	475	650
800	410	490	675
900	435	520	700
1000	455	545	725
1250	495	590	750
1500	525	625	775
1750	545	650	790
2000	555	665	800

** Refer to NEC 310.15(B)(2) for the ampacity correction factors where the ambient temperature is other than 30°C (86°F)

** Refer to NEC 240.4(D) for conductor overcurrent protection limitations.

NEC Table 310.15(B)(16): Allowed Ampacities of Insulated Conductors

	STANDBY (kW)	PRIME(kW)	STANDBY RATING AMPS			PRIME RATING AMPS			Phase Configuration
			120/208 3p	277/480 3p	120/240 3p	120/208 3p	277/480 3p	120/240 3p	
APD-UJP9	9	8	31.2	13.5	27.1	27.8	12	24.1	Three phase,Wye,Yn,Δ
APD-UJP13	13	12	45.1	19.5	39.1	41.6	18	36.1	Three phase,Wye,Yn,Δ
APD-UJP20	20	18	69.4	30.1	60.1	62.5	27.1	54.1	Three phase,Wye,Yn,Δ
APD-UJP28	28	26	97.2	42.1	84.2	90.2	39.1	78.2	Three phase,Wye,Yn,Δ
APD-UJP30	30	27	104.1	45.1	90.2	93.7	40.6	81.2	Three phase,Wye,Yn,Δ
APD-UJ30	30	27	104.1	45.1	90.2	93.7	40.6	81.2	Three phase,Wye,Yn,Δ
APD-UJ40	40	36	138.8	60.1	120.3	124.9	54.1	108.3	Three phase,Wye,Yn,Δ
APD-UJ55	55	50	190.8	82.7	165.4	173.5	75.2	150.4	Three phase,Wye,Yn,Δ
APD-UJP56	56	51	194.3	84.2	168.4	177	76.7	153.4	Three phase,Wye,Yn,Δ
APD-UJ65	65	59	225.5	97.7	195.5	204.7	88.7	177.4	Three phase,Wye,Yn,Δ
APD-UJP65	65	59	225.5	97.7	195.5	204.7	88.7	177.4	Three phase,Wye,Yn,Δ
APD-UJ80	80	72	277.6	120.3	240.6	249.8	108.3	216.5	Three phase,Wye,Yn,Δ
APD-UJP82	82	73	284.5	123.3	246.6	253.3	109.8	219.5	Three phase,Wye,Yn,Δ
APD-UJ100	100	90	347	150.4	300.7	312.3	135.3	270.6	Three phase,Wye,Yn,Δ
APD-UJP100	100	90	347	150.4	300.7	312.3	135.3	270.6	Three phase,Wye,Yn,Δ
APD-UJ125	125	113	433.7	187.9	375.9	392.1	169.9	339.8	Three phase,Wye,Yn,Δ
APD-UJ150	150	135	520.5	225.5	451.1	468.4	203	406	Three phase,Wye,Yn,Δ
APD-UJP150	150	135	520.5	225.5	451.1	468.4	203	406	Three phase,Wye,Yn,Δ
APD-UJP178	178	161	617.6	267.6	535.3	558.6	242.1	484.1	Three phase,Wye,Yn,Δ
APD-UJ180	180	162	624.6	270.6	541.3	562.1	243.6	487.2	Three phase,Wye,Yn,Δ
APD-UJ200	200	182	694	300.7	601.4	631.5	273.6	547.3	Three phase,Wye,Yn,Δ
APD-UJP200	200	182	694	300.7	601.4	631.5	273.6	547.3	Three phase,Wye,Yn,Δ
APD-UJP250	250	227	867.4	375.9	751.8	787.6	341.3	682.6	Three phase,Wye,Yn,Δ
APD-UJ250	250	227	867.4	375.9	751.8	787.6	341.3	682.6	Three phase,Wye,Yn,Δ
APD-UJ250	250	227	867.4	375.9	751.8	787.6	341.3	682.6	Three phase,Wye,Yn,Δ
APD-UJ275	275	250	954.2	413.5	827	867.4	375.9	751.8	Three phase,Wye,Yn,Δ
APD-UJ300	300	275	1040.9	451.1	902.1	954.2	413.5	827	Three phase,Wye,Yn,Δ
APD-UJP300	300	275	1040.9	451.1	902.1	954.2	413.5	827	Three phase,Wye,Yn,Δ
APD-UJ300	300	275	1040.9	451.1	902.1	954.2	413.5	827	Three phase,Wye,Yn,Δ
APD-UJ350	350	320	1214.4	526.2	1052.5	1110.3	481.1	962.3	Three phase,Wye,Yn,Δ
APD-UJP350	350	320	1214.4	526.2	1052.5	1110.3	481.1	962.3	Three phase,Wye,Yn,Δ
APD-UJ350	350	320	1214.4	526.2	1052.5	1110.3	481.1	962.3	Three phase,Wye,Yn,Δ
APD-UJ400	400	350	1387.9	601.4	1202.8	1214.4	526.2	1052.5	Three phase,Wye,Yn,Δ
APD-UJP400	400	350	1387.9	601.4	1202.8	1214.4	526.2	1052.5	Three phase,Wye,Yn,Δ
APD-UJ400	400	350	1387.9	601.4	1202.8	1214.4	526.2	1052.2	Three phase,Wye,Yn,Δ
APD-UJP461	461	410	1599.6	693.1	1386.3	1422.6	616.5	1232.9	Three phase,Wye,Yn,Δ
APD-UJ500	500	450	1734.9	751.8	1503.6	1561.4	676.6	1353.2	Three phase,Wye,Yn,Δ
APD-UJ500	500	450	1734.9	751.8	1503.6	1561.4	676.6	1353.2	Three phase,Wye,Yn,Δ
APD-UJP512	512	467	1776.5	769.8	1539.6	1620.4	702.2	1404.3	Three phase,Wye,Yn,Δ
APD-UJP565	565	N/A	1960.4	849.5	1699	N/A	N/A	N/A	Three phase,Wye,Yn,Δ
APD-UJ550	550		1908	827	1654				Three phase,Wye,Yn,Δ
APD-UJ600	600		2082	902	1804				Three phase,Wye,Yn,Δ
APD-UJP611	611	555	2120	918.7	1837.4	1925.7	834.5	1669	Three phase,Wye,Yn,Δ
APD-UJM800	800	720	2776	1203	2406	2498	1083	2165	Three phase,Wye,Yn,Δ
APD-UJM1000	1000	910	3470	1503	3007	3157	1368	2736	Three phase,Wye,Yn,Δ
APD-UJM-1250	1250	1125	N/A	1879	N/A	N/A	1692	N/A	Three phase,Wye,Yn,Δ
APD-UJM-1600	1600	1450	N/A	2406	N/A	N/A	2180	N/A	Three phase,Wye,Yn,Δ

APD-ULM-2000	2000	1800	N/A	3007	N/A	N/A	2706	N/A	Three phase,Wye,Yn,Δ
--------------	------	------	-----	------	-----	-----	------	-----	----------------------

	STANBY (Kw)	PRIME (kW)	STANDBY RATING AMPS	PRIME RATING AMPS	Phase Configuration
			120/240 1P	120/240 1P	
APD-ULP9	9	8	37.5	33.3	Single Phase
APD-ULP13	13	12	54.2	50	Single Phase
APD-ULP20	20	18	83.3	75	Single Phase
APD-ULP28	28	26	116.7	108.3	Single Phase
APD-ULP30	30	27	125	112.5	Single Phase
APD-ULJ30	30	27	125	112.5	Single Phase
APD-ULJ40	40	36	166.7	150	Single Phase
APD-ULJ55	55	50	229.2	208.3	Single Phase
APD-ULP56	56	51	233.3	212.5	Single Phase
APD-ULJ65	65	59	270.8	245.8	Single Phase
APD-ULP65	65	59	270.8	245.8	Single Phase
APD-ULJ80	80	72	333.3	300	Single Phase
APD-ULP82	82	73	341.7	304.2	Single Phase
APD-ULJ100	100	90	416.7	375	Single Phase
APD-ULP100	100	90	416.7	375	Single Phase
APD-ULJ125	125	113	520.8	470.8	Single Phase
APD-ULJ150	150	135	625	562.5	Single Phase
APD-ULP150	150	135	625	562.5	Single Phase

4. INSTALLATION, HANDLING AND STORAGE

4.1 General

Once the size of the generation set and any associated control systems of switchgear have been established, plans for installation can be prepared. This section discusses factors considered important for the effective and safe installation of the generating set.

4.2 Canopies

Installation and handling is simplified when the generating set has been equipped with a canopy. The canopy also gives protection from the elements and protection from unauthorized access.

4.3 Moving the Generating Set

The generating set base frame is specifically designed for ease of moving the set. Improper handling can seriously damage components.

Using a forklift, the generating set can be lifted or carefully pushed/pulled by the base frame directly using the forks. Always use wood between forks and the base frame to spread the load and prevent damage.

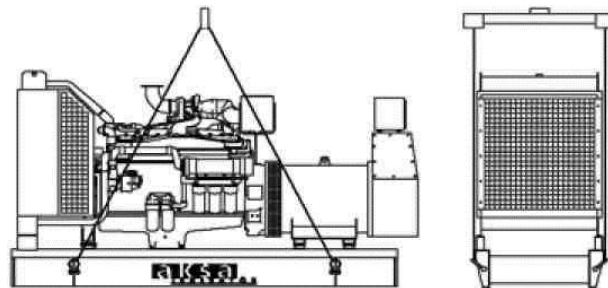

Figure 4.1 Lifting generating set by using a winch

Warning

- ! Never lift the generating set by attaching rigging to the engine or alternator lifting lugs.
- ! Ensure the lifting rigging and supporting structure is in good condition and is suitably rated.
- ! Keep all personnel away from the generating set while it is suspended.
- ! If the generating set is going to be lifted, it should be lifted by the lifting points fitted on canopied sets and most open sets.

4.4. Location

In order to start consideration for the possible layouts at a site, the following criteria must first be determined:

- The total area available and any restrictions within that area (i.e. buried or overhead services)

- A forced ventilation system is required for the equipment, which draws sufficient cooling and aspiration air into the room at the back of the alternator and discharges the air from the front of the engine. Depending upon the layout of the building, it may be necessary to install additional ductwork to achieve the airflow required.

- The access into the building, initially for the delivery and installation of the equipment, and afterwards for servicing and maintenance of the equipment.

- Protection from the elements such as rain, snow, sleet wind-driven precipitation, flood water, direct sunlight, freezing temperatures, or excessive heat.

- Protection from exposure to airborne contaminants such as abrasive or conductive dust, lint, smoke, oil mist, vapors, engine exhaust fumes, or other contaminants.

- Protection from the impact of falling objects such as trees or poles, from motor vehicles, or from lift trucks.

- Clearance around the generating set for cooling and service access: at least 3.3 feet around the set and at least 6.6 feet of headroom above the set.

- Access to move the entire generating set into the room. Air inlet and outlet vents can often be made removable to provide an access point. Access to unauthorized personnel should be limited.

- If it is necessary to locate the generating set outside of the building, the generating set should be enclosed in a canopy. A canopy is also useful for temporary installations inside or outside of the building.

4.5. Base and Foundation

Note: Special foundations are unnecessary. A level and sufficiently strong concrete floor is adequate. The responsibility for the foundation (including seismic considerations) should be placed with a civil or structural engineer specializing in this type of work.

Major functions of a foundation are to:

Support the total weight of the generating set. Considering the vibration by the generating set, it should be isolated from surrounding structures.

To support the structural design, the civil engineer will need the following details:

- The plant's operating temperatures.
- The overall dimensions of the proposed foundation mass.
- The mounting and fixing arrangements of the generator bed-frame.

Concrete Foundations:

The foundation will require at least seven days between pouring the concrete and mounting the generating set to cure. It is also essential that the foundation be level, preferably within $\pm 0.5^\circ$ of any horizontal plane and should rest on undisturbed soil.

The following formula may be used to calculate the minimum foundation depth:

$$t = \frac{k}{d \times w \times l}$$

t=thickness of foundation in ft

k=net weight of set in lbs

d=density of concrete (take 150 lb/ft³)

w=width of foundation in (ft)

l=length of foundation in (ft)

The foundation strength may still vary depending on the safe bearing capacity of supporting materials and the soil bearing load of the installation site. Therefore, reinforced gauge steel wire mesh, reinforcing bars, or some equivalent may be required.

Vibration Isolation

Each generating set is built as single module with the engine and alternator coupled together through a coupling chamber. This chamber utilizes resilient mounting to form one unit of immense strength and rigidity. This provides both accuracy of alignment between the engine and alternator and damping of engine vibration. This reduces the need for heavy concrete foundations that would normally be used to absorb engine vibrations so that all the generator required is a level concrete floor to take the distributed weight of the unit.

Foundation

A reinforced concrete pad provides a rigid support to prevent deflection and vibration. Typically, the foundation should be 6 to 8 inches (150 mm to 200 mm) deep and at least as wide and long as the generating set. The ground or floor below the foundation should be properly prepared and structurally suited to carry the weight of the foundation pad and the generating set. (If the generating set is to be installed above the ground floor, the building structure must be able to support the weight of the generating set, fuel storage, and accessories). If there is a chance that moisture will accumulate on the floor such as in a boiler room, the pad should be raised above the floor. This will provide a dry footing for the generating set and for those who connect, service, or operate it. It will also minimize corrosive action on the base-frame.

Levelling

A poor foundation may result in unnecessary vibration of the genset.

Connections

All piping and electrical connections should be flexible to prevent any damage caused by movement of the generation set.

Fuel and water lines, exhaust pipes and conduit can transmit vibrations at long distances.

4.6. Room Design Guidance Notes

4.6.1. Room Size Allowance

The dimensions as indicated in A & B allow for good maintenance/escape access around the generator. Ideally, a minimum distance of 30 inches should be allowed from any wall, tank or panel within the room.

4.6.2. Inlet and Outlet Attenuators with Weather Louvers

The inlet and outlet attenuators should be installed within a wooden frame. The attenuators are based off of 4-inch airways and 8-inch acoustic modules. The attenuators should be fitted with weather louvers with a minimum of 50% free area, good airflow profile, and afford low restriction airflow access.

The weather louvers should have bird/vermin mesh screens fitted on the inside, but these screens must not impede the free flow of cooling and aspiration air. The outlet attenuator should be connected to the radiator ducting flange with a heat and oil resistant flexible connection.

4.6.3. Combustion Air Inlet

Air for engine combustion must be as clean and as cool as possible. Normally, this air can be drawn from the area surrounding the generating set via the engine-mounted air filter. However, in some cases due to dust, dirt, or heat, the air around the set is unsuitable. In these cases, an inlet duct should run from the source of clean air (outside the building, another room, etc) to the engine –mounted air filter. Do not remove the air filter and mount it at a remote location as this can increase the possibility of dirt leaking through the ductwork and into the engine inlet.

4.6.4. Exhaust Systems

The exhaust systems shown on the layout drawings are supported by the ceiling. Should the building construction be such that the roof supports are unable to support the exhaust system, a system of support coming up from the floor will be needed for the steel exhaust. Exhaust pipes should terminate at least 7.5ft above floor level to make it reasonably safe for anyone passing by.

It is recommended that stainless steel bellows be fitted to the engine exhaust manifold followed by rigid pipe work to the silencer.

It is good installation practice for the exhaust system within the generator room to be insulated with a minimum of 2-inches. Of high- density, high-temperature mineral insulation covered by an aluminum overclad. This reduced the possibility of operator bum injury and reduces the heat being transferred to the operating generator room.

4.6.5. Cooling and Ventilation

The engine, alternator, and exhaust pipes radiate heat which may result in temperatures high enough to adversely affect the performance of the generating set. It is, therefore, important that adequate ventilation is provided to keep the engine and alternator cool. Proper air flow, as shown in Figure 4.4., requires that the air comes in at the alternator end of the set, passes over the engine, through the radiator, and out of the room via a flexible outside, the fan will tend to draw the hot air back through the radiator reducing the cooling effectiveness.

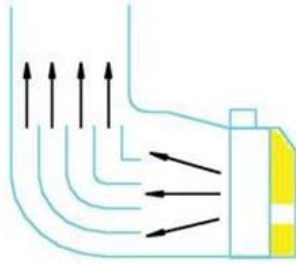

Figure 4.2 Directing the air thrown from the radiator with deviating wings.

Sharp corners on the radiator hot air out let channel or its chimney must be avoided. Sharp corners can cause vented air to become trapped and recirculated reduce effectiveness of the cooling cycle (Figure 4.2. and 4.3.).

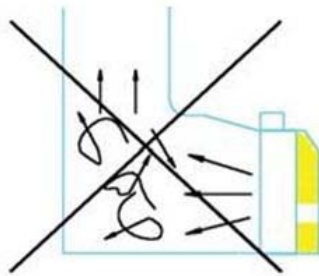

Figure 4.3 Weak ventilation

The air inlet and outlet openings should be large enough to ensure free flow of air into and out of the room. A good estimation for the openings would be to make them at least 1.5 times the area of the radiator core.

Both the inlet and outlet openings should have louvers for weather protection. These may be fixed, but preferably, should be movable in cold climates so that while the generating set is not operating the louvers can be closed. This will allow the room to be kept warm which will assist with starting and load acceptance. For automatically starting generating sets, if the louvers are movable, they must be automatically operated. They should be programmed to open immediately upon starting the engine.

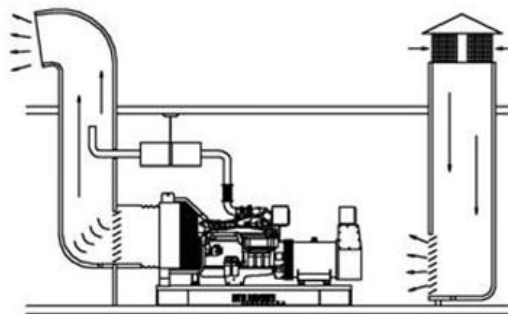

Figure 4.4 Air ventilation

4.6.6. Cable Systems

The layout drawing assumes that the change-over switch-gear is external to the generator room and located in the power distribution room. Specific project requirements can affect this layout.

The power output cables from the generator output breaker to the distribution panel must be a flexible type. The flexible power cables as installed should be laid up in trefoil, placed on support trays/ladder rack in the trench with the recommended inter-spacing, and segregated from the system control cables.

The cables should be correctly supported and rated for the installation/ambient conditions.

The flexible single core power cables, when entering any panel, must pass through a non-ferrous gland plate.

4.6.7. Change – Over Panels

For change-over cubicles rated up to 400 Amp, the wall mounting panel with a maximum depth of 13-3/4 inches can be mounted directly above the cable trench on the side. For change-over cubicles rated at 800 Amp and higher, a floor standing panel is used which needs additionally allocated space. A minimum of 31-1/2 inches should be allowed for rear access.

4.6.8. Doors

Doors should always open outwards. Make any necessary allowance for the generator to be moved into the room by using double doors at the attenuator space.

4.6.9. Inlet and Outlet Louvers

The inlet and outlet weather louvers should be installed within a wooden frame having a minimum 50% free area, good airflow profile, and low restriction airflow access.

The weather louvers should have bird/vermin mesh screens fitted on the inside, but must not impede the free flow of cooling and aspiration air.

The outlet weather louver should be connected to the radiator ducting flange with a heat and oil resistant flexible connection.

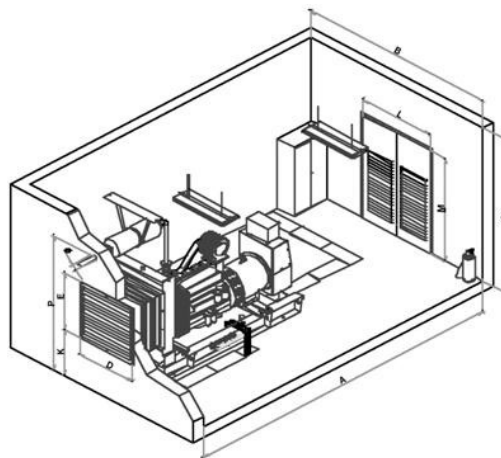

Figure 4.5 Generating set room

Genset		Generating Set Dimensions(ft)			Room dimensions(ft)			Radiator Hot Air Outlet Openings Louvers (ft)			Air Inlet Openings Total Area (ft2)	Room's Door Dimensions(ft)	
		open											
Model	Standby Power (KW)	Length	Width	Height	Length	Width	Height	D	E	K	ft2	W	H
APD-UJP9	9	4.59	2.58	3.03	11	9	9.6	2.3	2.46	1.64	8.6	6.6	7.22
APD-UJP13	13	4.59	2.58	3.22	11	9	9.6	2.3	2.46	1.64	8.6	6.6	7.22
APD-UJP20	20	6	3.28	3.18	12.56	9.8	9.6	2.3	2.46	1.64	8.6	6.6	7.22
APD-UJP28	28	6	3.28	3.6	12.56	9.8	9.6	2.3	2.46	1.64	8.6	6.6	7.22
APD-UJ30	30	6	3.28	3.72	12.56	9.8	9.6	2.3	2.46	1.64	8.6	6.6	7.22
APD-UJP30	30	6	3.28	3.68	12.56	9.8	9.6	2.3	2.46	1.64	8.6	6.6	7.22
APD-UJ40	40	6	3.28	3.72	12.56	9.8	9.6	2.3	2.62	1.64	8.6	6.6	7.22
APD-UJ55	55	7.67	3.61	4.46	14.23	10	9.6	2.3	2.62	1.64	10.76	6.6	7.22
APD-UJP56	56	7.67	3.61	4.46	14.23	10	9.6	2.3	2.62	1.64	10.76	6.6	7.22
APD-UJ65	65	7.67	3.61	4.46	14.23	10	9.6	2.46	2.62	1.64	10.76	6.6	7.22
APD-UJP65	65	7.67	3.61	4.46	14.23	10	9.6	2.46	2.62	1.64	10.76	6.6	7.22
APD-UJ80	80	7.67	3.61	4.46	14.23	10	9.6	2.46	2.62	1.64	10.76	6.6	7.22
APD-UJP82	82	7.67	3.61	4.46	14.23	10	9.6	2.46	2.62	1.64	10.76	6.6	7.22
APD-UJP100	100	7.67	3.61	4.46	14.23	10	9.6	2.62	2.95	1.64	10.76	6.6	7.22
APD-UJ100	100	9.64	3.61	4.46	17.8	10	9.6	2.62	2.95	1.64	10.76	6.6	7.22
APD-UJ125	125	9.64	3.61	4.46	17.8	10	9.6	2.62	2.95	1.64	16.13	6.6	7.22
APD-UJ150	150	9.64	3.61	4.46	17.8	10	9.6	3.61	3.28	1.97	16.13	6.6	7.22
APD-UJP150	150	9.64	3.61	4.46	17.8	10	9.6	3.61	3.28	1.97	16.13	6.6	7.22
APD-UJP178	178	9.64	3.61	4.46	17.8	10	9.6	3.61	3.28	1.97	16.13	6.6	7.22
APD-UJ180	180	9.64	3.61	4.46	17.8	10	9.6	3.61	3.28	1.97	16.13	6.6	7.22
APD-UJP200	200	10.5	4.59	5.22	18.7	12.8	9.6	3.61	3.28	1.97	16.13	6.6	7.22
APD-UJ200	200	10.5	4.59	5.22	18.7	12.8	9.6	3.61	3.28	1.97	16.13	6.6	7.22
APD-UJ250	250	10.5	4.59	5.22	18.7	12.8	9.6	2.46	2.62	1.64	16.13	6.6	7.22
APD-ULV250	250	10.5	4.59	5.22	18.7	12.8	9.6	2.46	2.62	1.64	16.13	6.6	7.22
APD-UJ275	275	10.5	4.59	5.22	18.7	12.8	9.6	2.46	2.62	1.64	16.13	6.6	7.22
APD-UJ300	300	13.12	6.23	5.92	23	16	12.7	2.46	2.62	1.64	38.73	8	8
APD-UJP300	300	13.12	6.23	6.12	23	16	12.7	2.46	2.62	1.64	38.73	8	8
APD-ULV300	300	13.12	6.23	6.12	23	16	12.7	2.46	2.62	1.64	38.73	8	8
APD-UJ350	350	13.12	6.23	5.92	23	16	12.7	2.46	2.62	1.64	38.73	8	8
APD-UJP350	350	13.12	6.23	6.12	23	16	12.7	2.46	2.62	1.64	38.73	8	8
APD-ULV350	350	13.12	6.23	6.12	23	16	12.7	2.46	2.62	1.64	38.73	8	8
APD-UJ400	400	13.12	6.23	5.92	23	16	12.7	2.62	2.95	1.64	38.73	8	8
APD-UJP400	400	13.12	6.23	6.12	23	16	12.7	2.62	2.95	1.64	38.73	8	8
APD-ULV400	400	13.12	6.23	6.12	23	16	12.7	2.62	2.95	1.64	38.73	8	8
APD-UJP461	461	13.12	6.23	6.1	23	16	12.7	2.62	2.95	1.64	38.73	8	8
APD-UJ500	500	13.12	6.23	5.92	23	16	12.7	3.61	3.28	1.97	38.73	8	8
APD-ULV500	500	13.12	6.23	5.92	23	16	12.7	3.61	3.28	1.97	38.73	8	8
APD-UJP512	512	13.12	6.23	6.1	23	16	12.7	3.61	3.28	1.97	38.73	8	8
APD-ULV550	550	13.12	6.23	6.1	23	16	12.7	3.61	3.28	1.97	38.73	8	8
APD-UJP565	565	13.12	6.23	6.1	23	16	12.7	3.61	3.28	1.97	38.73	8	8
APD-ULV600	600	13.12	6.23	6.1	23	16	12.7	3.61	3.28	1.97	38.73	8	8
APD-UJP611	611	13.12	6.23	6.22	23	16	12.7	3.61	3.28	1.97	38.73	8	8
APD-ULM800	800	16.41	7.42	6.93	29.5	20.5	14.8	NA	NA	NA	NA	10	9.2
APD-ULM1000	1000	17.39	7.42	7.39	30.5	20.5	15.6	NA	NA	NA	NA	10	10
APD-ULM1250	1250	NA	NA	NA	NA	NA	NA	NA	NA	NA	NA	NA	NA
APD-ULM1600	1600	NA	NA	NA	NA	NA	NA	NA	NA	NA	NA	NA	NA
APD-ULM2000	2000	NA	NA	NA	NA	NA	NA	NA	NA	NA	NA	NA	NA

5. FUEL SYSTEM

5.1. General

Depending upon the specific site layout, the fuel can be supplied to the engine either from:

1. The sub-base fuel tank located under the generating set.
2. An intermediate daily service tank located within the plant room or generator enclosure which will be automatically refilled from a bulk storage tank.
3. Directly from the bulk storage tank provided that the outlet connection from this tank is at least 20 inches higher than the base upon which the generator is mounted.

It is very important that the fuel oil purchased for use in any engine be as clean and water-free as possible. Dirt in the fuel can clog injector outlets and ruin the finely machined precision parts in the fuel injection system. Water in the fuel will accelerate corrosion of these parts.

5.2. Diesel Fuel Recommendations

The following fuel oil specification is typical

Diesel Fuel Recommended Physical Properties Specifications.

Viscosity(ASTM D445)	1.3 to 5.8 centi strokes(0.05 to 0.23 in per second) at 104°F(1048F)
Cetane Number(ASTM D613)	40 Minimum above 32°F(0°C) 45 Minimum above 32°F(0°C)
Sulphur Content	Not to exceed 0.5 mass percent
(ASTM D1796)	Not to exceed 0.05 volume percent
Density(ASTM D287)	42 to 30 API GRAVITY AT 60°F(0.816 to 0.876 g/cc at 15°C)
Cloud Point(ASTM D287)	10°F(6°C) below lowest ambient temperature at which the fuel is expected to operate
Ash(ASTM D482)	Not to exceed 0.02 mass percent(0.05 mass percent with lubricating oil blending)
Lubricity	3100 grams or greater

Table 5.1

Diesel Fuel Property Definition

Ash – Mineral residue in fuel. High ash content leads to excessive oxide build-up in the cylinder and/or injector. Cetane

Number – Ignitability of fuel. The lower the cetane number is, the harder it is to start and run the engine. Low cetane fuels ignite later and burn slower. This could lead to explosive detonation by having excessive fuel in the chamber at the time of ignition. In cold water or with prolonged low loads, a higher cetane number is desirable.

Cloud and Pour Points – The pour point is the temperature at which the fuel will not flow. The cloud point is the temperature at which the wax crystals separate from the fuel.

The pour point should be at least 6°C (10°F) below the ambient temperature to allow the fuel to move through the lines. The cloud point must be no more than 6°C (10°F) above the pour point so the wax crystals will not settle out of the fuel and plug the filtration system.

Sulfur – The amount of sulfur residue in the fuel. The sulfur combines with the moisture formed during combustion to form sulfuric acid.

Viscosity – Influences the size of the atomized droplets during injection. Improper viscosity can lead to detonation, power loss, and excessive smoke. Fuels that meet the requirements of ASTM or 2.0 diesel fuels are satisfactory with fuel systems.

5.3. Base Fuel Tank

Generating sets up to 2000Kw can be supplied with or without base fuel tanks. The room height should allow for this feature.

Recommended room layout drawings incorporate base fuel tanks on the generators.

This provides a self-contained installation without the addition of external fuel lines, trenches, or fuel transfer pumps. Generators with base tanks are delivered fully connected and ready to run.

5.4. Bulk Storage Tanks

The purpose of the fuel-supply system is to store an adequate quantity of fuel to suit the application for which the system is intended. The bulk storage tanks should be sized accordingly.

The filling of the tanks will be by means of a fill connection housed in a suitable, lockable, cabinet located so as to permit easy access by any means of fuel delivery. This cabinet may also house a contents gauge and an overfill alarm connected to the float switch inserted into a manhole on the tank.

5.5. Without Intermediate Fuel Tank (Fig.5.1.)

The simplest arrangement would be supply the engine directly from the bulk storage tank and return the infector spill directly to this tank. A typical arrangement for this is shown if Fig.5.1. The principle limitations of this method are: In order to gravity feed the engine, the outlet from the bulk storage tank must be a minimum of 23-5/8 inches above the generator plinth level; The pressure drop of the spill return pipe work must not exceed that detailed in the Engine Data sheet; The supply pipe work from the bulk storage tank to the engine must be sized to allow the total volume of fuel required by the engine to flow under gravity.

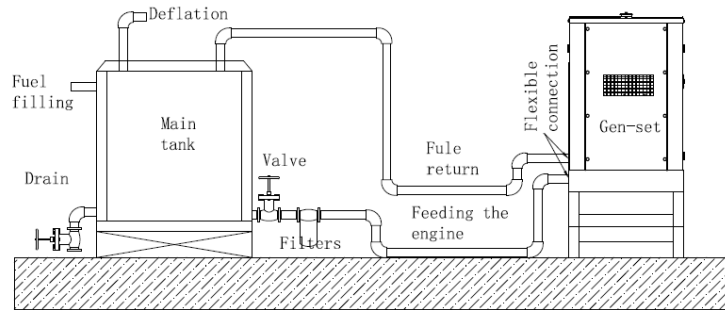

Figure 5.1 Without Intermediate Fuel Tank

5.6. With Intermediate Fuel Tank (Fig.5.2)

Where it is not possible to supply the engine direct from the bulk tank due to site constraints, an intermediate tank can be located within the plant room/generator enclosure which supplies fuel directly to the engine.

This type of system can be further enhanced by the addition of the following optional items of equipment:

1. An automatic duplex fuel transfer pump and primary filter system arranged to start the standby pump should the duty pump fail. The transfer pump(s) must be sized to cater for the total fuel required by the engine, i.e. fuel consumed and the spill return volumes (Fig.5.2.)
2. A fusible link operated dead weight drop valve designed to cut off the supply of fuel to the intermediate tank and to transmit a signal in the vent of fire;
3. A fusible, link operated, dump valve arranged to dump the contents of local tank back into the bulk tank in the event of a fire within the generator enclosure.

The connection details for these additional items of equipment are indicated. See Fig. 5.2.

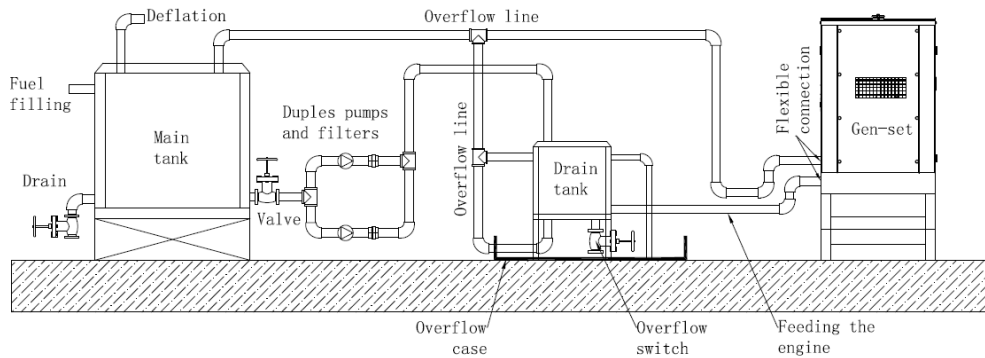

Figure 5.2 With Intermediate Fuel Tank.

5.7. Daily Service Fuel Tank

Separate daily service tank can be provided based on customer requirements. It would also include a transfer system arranged to automatically feed from the bulk storage tank electric, motor driven, pump(s) operating from signals from a level sensing float switch. Fuel tanks should not be made from galvanized iron as diesel fuel oil reacts against zinc.

A vent pipe should be extended to the highest point of the fuel system installation. The diameter of the pipe should at least match that of the fill connection. Provision should be made to prevent the ingress of dirt. The overflow from the daily service intermediate tank can either be:

1. Piped directly back to the bulk storage tank;
2. Piped into the bund of the intermediate tank with a bund level alarm system arranged to cut off the fuel transfer pump system upon detection of spillage.
3. Piped to overflow into the bunded area. The feed connection on the tank should not be lower than 23.6 in above the level on which the engine sits in order to maintain gravity feed to the engine. When the intermediate tank is located at a lower level than the bulk storage tank, it is essential that a solenoid valve be incorporated into the transfer line. All final connections to the engine should be in flexible hose to restrict vibration transmission through the pipe.

5.8. Determining Pipe Sizes

Minimum pipe sizes are determined by the size of the inlet to the fuel transfer pump. The pipe inner diameter (ID) must be at least as large as the transfer pump inlet. If the piping must carry the fuel over long distances, the pipe size must be increased. An auxiliary transfer pump at the tank outlet may also be needed to avoid high suction pressure within the piping. In all cases, excessive fuel line suction pressures must be avoided. At high suction pressures, the fuel will vaporize in the piping and the fuel supply to the engine will be decreased. When sizing piping, always remember to account for pressure drop across filters, fittings, and restriction valves. A flex connector must be added to isolate the engine vibration from the fuel piping. If this vibration is not isolated, the piping could rupture and leak. The flexible connector must be as close to the engine transfer pumps as possible. Any expanse of exposed piping must be properly supported to prevent piping ruptures.

Use pipe hangers to isolate vibration from the system. Exposed fuel piping must never run near heating pipes, furnaces, electrical wiring, or exhaust manifolds. The area around the piping is warm, the fuel lines should be insulated to prevent the fuel and piping from picking up any excess heat. All pipes should be inspected for leaks and general condition including cleanliness before installation. Back flush all lines to the tank before start-up to avoid pulling excess dirt into the engine and fuel piping system. After installation, the air should be bled from the fuel system. A hand valve should be included at some high point in the system to allow air removal. Use plugged tees, not elbows, to make piping bends. This will allow for cleaning by removing the plugs and flushing out the lines. All threaded pipe fittings must be sealed with a suitable paste.

Caution: Do not use tape to seal fuel line fittings. Pieces of tape could shear off and jam in the pump or injectors. Inlet minimum and maximum pressure at the point of connection to the supply piping for units that require a pressurized fuel input is 2.6-0.3PSI.

5.9. Fuel Return Lines

Fuel return lines take the hot excess fuel not used in the engine cycle away from the injectors and back to either the fuel storage tank or the day tank. The heat from the excess fuel is dissipated in the tank.

Caution: Never run a fuel return line directly back to the engine fuel supply lines. The fuel will overheat and break down.

The fuel return lines should always enter the storage or day tank above the highest fuel level expected. This statement is true for all powered engines with the PT fuel system. The fuel return line should never be less than one pipe size smaller than the fuel supply line.

WARNING

- The fuel must be clean and must not contain any water.
- Do not use galvanized pipe for fuel pipe.
- When the engine stops, there should not be any gravitational free flow in the fuel pipes towards in the direction of the engine.
- The fuel temperature is a critical factor for appropriate working conditions of the engine. Fuel temperatures above 160°F, due to expansion of the fuel, will decrease the engine output power.

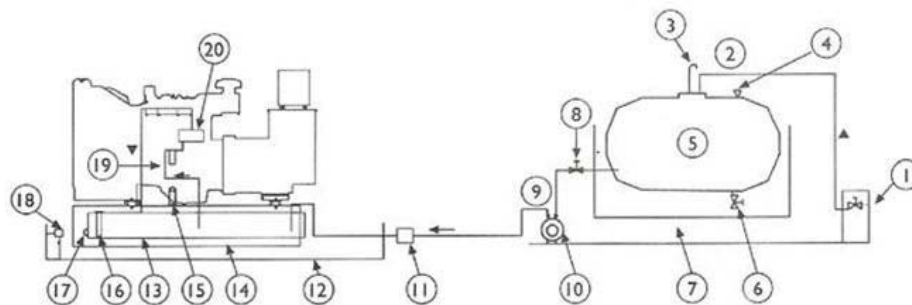
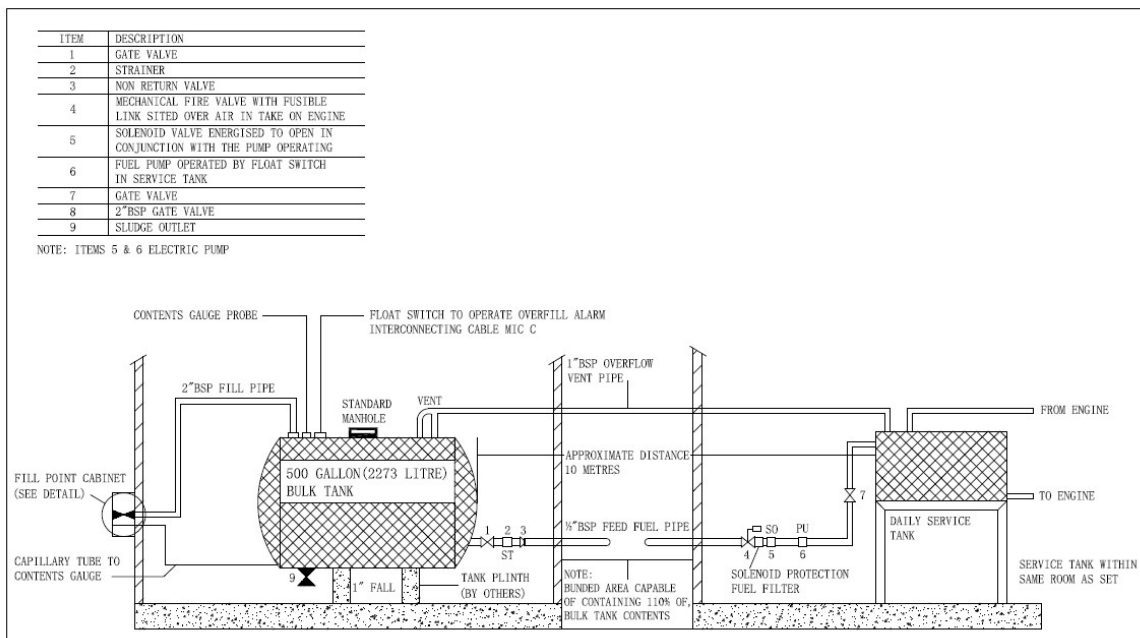

Figure 5.3. Typical fuel installation using a base tank fed from a bulk tank

- In fuel system lines, using a fuel filter will prevent the injectors and fuel pump from building up particulates and clogging. It is also useful for healthy working of the engine.

1. Fill cabinet with overfill alarm and gauge
2. Tank fill line
3. Vent line
4. Contents gauge
5. Bulk storage tank
6. Sludge drain
7. Bund tank
8. Outlet valve
9. Supply line to day tank
10. . Electric fuel transfer pump
11. . Electrical fuel shut off valve
12. . Optional band
13. . Day tank incorporated in base frame
14. . Float Control switches
15. . Manuel fill and vent
16. . Level gauge
17. . Drain
18. . Leakage alarm unit (optional)
19. . Fuel filter
20. . Engine fuel pump



6. COOLANT TREATMENT

6.1. General

The engine cooling system is subject to rust and cavitation. To minimize the severity of this condition, an anti-corrosive agent can be added to clean coolant water.

An anti-freeze solution is also required to prevent freezing of the coolant in the cold weather.

6.2. Engine Coolant

Water for coolant should be clean and free from any corrosive chemicals such as chlorides, sulphates, or acids. It should be kept slightly alkaline with a pH value ranging from 8.5 to 10.5 generally; any water that is suitable for drinking can be used, with treatment, as described below.

Protection against corrosion

Supplemental Coolant Additive is required to protect the cooling system from fouling, solder blooming, and general corrosion.

The use of antifreeze is also recommended as DCA4 concentrations are dependent upon the presence of antifreeze. Antifreeze also interacts with DCA4 to provide greater corrosion and protection against cavitation.

Procedure for Treating Coolant

1. Add the required amount of water and DCA to mixing container and mix it thoroughly.
2. Add the required amount of antifreeze, if used, to the water solution and mix thoroughly.
3. Add the coolant to the cooling system

Cold Weather Protection

Antifreeze must be added to the coolant to protect the engine from damage due to coolant freezing. A 1:1 water/antifreeze mixture ratio is recommended. Low- silicate antifreeze is recommended.

6.3. Engine Warming

There are thermostatically controlled water jacket heaters operating from the main's supply. There are fitted into the cooling system. And they maintain the temperature of the coolant in cold weather. A heater alone, fitted in the radiator, will not be adequate for starting or preventing freezing, so an antifreeze mixture should be used.

7. EXHAUST SYSTEM

7.1. Sizing

An exhaust system should be designed to dispel the exhaust gases to atmosphere at the nearest convenient point in an installation. The length of the run and the number of changes in direction should be kept to a minimum.

The calculation of the effect on the back pressure is based upon the restriction through the straight lengths of pipe, the bends, and the silencers. The smaller the bore of the pipe is, the greater its length is, and the more times it changes its direction all increase the resistance to flow. The back pressure limit for most engines is 3 inHg (76 mmHg) Take an estimate of the size of the pipe by starting with the bore of the exhaust flange off the manifold and increasing the size by 1" for each 20 ft. length or 3 x 90 bends.

7.2. Routing

Once the final size and route of the pipe work and the silencer have been established, the exhaust route can be determined if the following factors are taken into consideration:

A flexible bellows unit must be fitted on the engine connection to allow the engine to move on its mountings; If the silencer is to be located within the plant room, due to its physical size and weight , it needs to be supported from the floor;

It may be necessary to install expansion joints at each change of direction to compensate for the thermal growth in the pipe during operation;

The inner radius of a 90° bend should be 3 times the diameter of the pipe See Fig. 7.1.

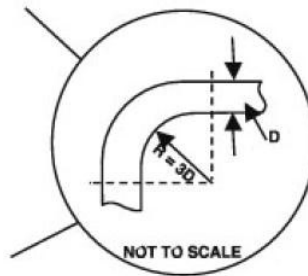

Fig. 7.1 Exhaust bend and radius

The primary silencer should be mounted as close as possible to the engine;

The termination point should not be directed at combustible materials/structures, into hazardous atmospheres containing flammable vapors, where there is a danger that the gases will re-enter the plant room through the inlet air vent, or into any opening that leads to another building in the vicinity.

All rigid pipe work should be installed in such a manner that the engine's exhaust outlet is not stressed. Pipes should be routed so that they are supported by fixtures to the building fabric or by existing structural steelwork where such methods are acceptable;

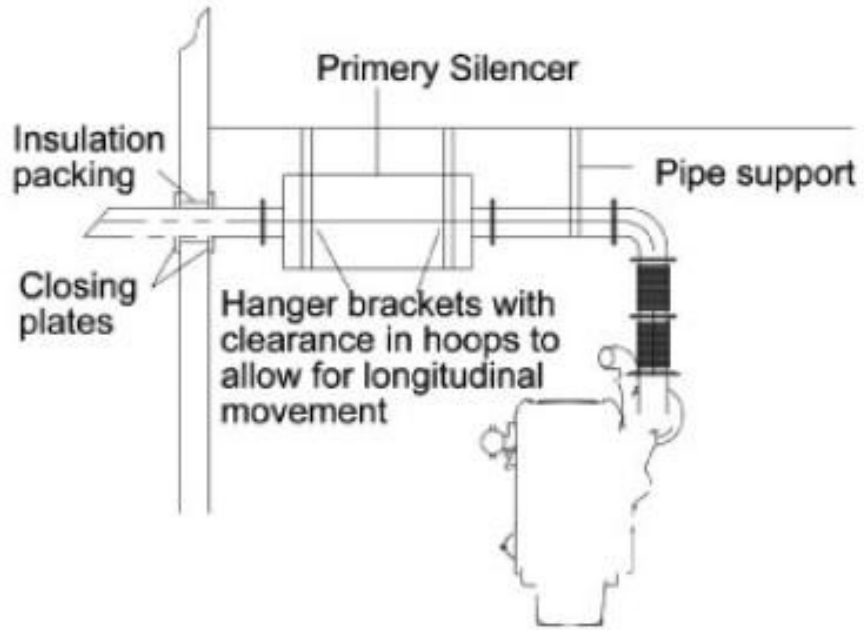

Fig. 7.2 Exhaust system

8. LUBRICATING OIL

The oil system of diesel engine is one of the most important elements of the engine. Proper engine maintenance (this subject includes oil change periods, filter change periods, paying attention about selecting the true type of oil) significantly prolongs the life cost of the engine.

8.1. Oil Performance Properties

The American Petroleum Institute (API) the American Society for Testing and Materials (ASTM) and Society of Automotive Engineers (SAE) has developed and preserved a system in order to classify the lubrication oils for their performance categories.

8.2. Lubrication Recommendations for Engine

Aksa recommends that high quality multi-grade SAE 15W/40 high service engine oil in diesel engines are used. At ambient temperatures above -15°F is 15W40.

The minimum API oil quality levels recommended for use is CH / CI-4, CH or CI-4 can be used in areas where CF4 oil is not yet available, but the oil interval must be reduced API CA, CB, CC, CD, CE, CG4 categories not recommended, do not use.

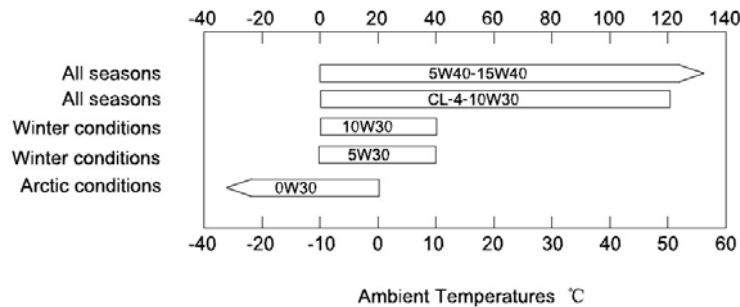

Figure: 8.1 Recommended SAE Oil Viscosity Grades vs. Ambient Temperatures

Genset			Consumption at Full Load	Coolant Capacity (qt)	Oil Capacity (qt)	Note:Lubricating oil viscosity level will be chosen from table 8.1 according to the ambient temperature
Model	Standby Power (KW)	Engine Model				
APD-ULP9	9	403D-11G	0.82	5.49	5.18	API CH
APD-ULP13	13	403D-15G	1.14	6.34	6.34	API CH
APD-ULP20	20	404D-22G	1.64	7.4	11.2	API CH
APD-ULP28	28	404D-22TG	2.19	9.93	11.2	API CH
APD-ULP30	30	404D-22TAG	2.35	TBD	11.2	API CH
APD-ULJ30	30	3029TFG89	2.59	6.02	6.34	API CH
APD-ULJ40	40	3029HFG89	3.54	6.02	6.34	API CH
APD-ULP56	56	1104D-44TG1	4.39	13.95	8.88	API CH
APD-ULJ55	55	4045TF280	4.6	8.98	13.74	API CH
APD-ULP65	65	1104D-E44TG1	4.94	13.95	8.88	API CH
APD-ULJ65	65	4045HF280	5.1	8.98	13.74	API CH
APD-ULJ80	80	4045HF285	6.6	8.98	13.74	API CH
APD-ULP82	82	1104D-E44TAG1	6.26	17.96	8.45	API CH
APD-ULJ100	100	4045HF285	8.22	8.98	13.74	API CH
APD-ULP100	100	1104D-E44TAG2	7.34	17.96	8.45	API CH
APD-ULJ125	125	4045HF285	9.85	8.98	13.74	API CH
APD-ULJ150	150	6068HF285	11.8	12.57	34.34	API CH
APD-ULP150	150	1106D-E66TAG3	10.59	22.19	17.44	API CH
APD-ULP178	178	1106D-E66TAG4	12.81	22.19	17.44	API CH
APD-ULJ180	180	6068HFG82	13.5	12.57	33.8	API CH
APD-ULJ200	200	6068HF485	15.4	12.57	34.34	API CH
APD-ULP200	200	1106D-E70TAG5	15.4	12.57	TBD	API CH
APD-ULJ250	250	6090HF484	17.99	16.91	34.34	API CH
APD-ULV250	250	TAD1351GE	210	21.12	31.6	API CH
APD-ULJ275	275	6090HFG86	19.6	16.91	32.76	API CH
APD-ULP300	300	2206D-E13TAG2	22.98	54.31	42.27	API CH
APD-ULJ300	300	6090HFG86	22.1	16.91	32.76	API CH
APD-ULV300	300	TAD1351GE	210	21.12	31.6	API CH
APD-ULJ350	350	6135HFG84	26.4	19.02	32.76	API CH
APD-ULP350	350	2206D-E13TAG2	22.98	54.31	42.27	API CH
APD-ULV350	350	TAD1352GE	26.8	25.36	38.0	API CH
APD-ULJ400	400	6135HF485	29.19	19.02	36.40	API CH
APD-ULP400	400	2206D-E13TAG3	24.83	54.31	42.27	API CH
APD-ULV400	400	TAD1353GE	26.8	25.36	38.0	API CH
APD-ULP461	461	2506D-E15TAG1	29.85	61.29	65.52	API CH
APD-ULJ500	500	6135HFG75	35.32	19.02	42.27	API CH
APD-ULV500	500	TAD1641GE	35.5	63.4	50.8	API CH
APD-ULP512	512	2506C-E15TAG3	31.96	61.29	65.52	API CH
APD-ULV550	550	TAD1642GE	38.5	63.4	50.8	API CH
APD-ULP565	565	2506C-E15TAG4	35.13	61.29	65.52	API CH
APD-ULP611	611	2806C-E18TAG3	38.3	64.46	65.52	API CH
APD-ULV600	600	TWD1643GE	163.2	50.72	50.8	API CH
APD-ULM800	800	S12A2-Y2PTAW	58.38	105.67	126.8	API CH
APD-ULM1000	1000	S12H-Y2PTAW	69.95	105.67	211.34	API CH

APD-ULM1250	1250	S12R-Y2PTAW	90.62	137.37	190.21	API	CH
APD-ULM1600	1600	S16R-Y2PTAW	114.7	179.64	243.04	API	CH
APD-ULM2000	2000	S16R-Y2PTAW2	141.07	179.64	243.04	API	CH

Table 8.1 Fuel consumption and coolant, fuel, and lubricating oil capacities and lubricating oil systems.

9. ELECTRIC STARTING SYSTEMS

Electric starting systems are generally used on all gen-sets. The power source for electric starting systems is a 12 or 24 VDC battery system. The starting voltage is determined by engine size with 24 VDC being used for larger engines to reduce starting current and, hence, the cable size. Control of starting is performed via a start solenoid which is controlled by the gen-set control system.

9.1. Battery Systems

Batteries are of two types - lead acid and NiCad. Lead acid batteries are generally used, being the least expensive. NiCad batteries are used where longer life, etc., is required.

9.2. Batteries Warning

Servicing of batteries is to be performed or supervised by trained personnel with knowledge of batteries and required precautions. Keep unauthorized personnel away from batteries.

When replacing batteries, use the same number and the valve regulated (Maintenance-free) type batteries.

CAUTION- Do not dispose of any battery by setting fire to it. The battery is capable of exploding.

CAUTION- Do not open or mutilate any battery. The released electrolyte has been known to be harmful to the skin and eyes and can be fatal.

CAUTION- A battery presents a risk of electrical shock and high short circuit current. The following precautions are to be observed when working on batteries:

1. Remove watches, rings, or other metal objects.
2. Only use tools with insulated handles.

9.3. Battery Maintenance

- Keep the top of the battery and its terminals clean.
- Cover the battery terminals and its connections with Vaseline.
- Tighten the terminals until they do not move freely. Do not over tighten.
- Check the electrolyte level periodically. It should be approximately 3/8" above the plates.
- Periodically check for any abrasions on the alternator belt and also check the tension. Compare the belt tension to the producer's recommendations and adjust if required.
- Periodically check to make sure that the battery is charged.

9.4. Maintenance Free Batteries

Ensure that all battery connections are correct and batteries are always charged.

9.5. Starting Aids

It is customary to keep coolant temperatures at or above 104°F in order to promote quick starting on an emergency generating plant. Thermostatically controlled immersion heaters, deriving their supply from the primary source of power, are fitted into the engine cooling system to provide this heating.

9.6. Cold Cranking Ampere Rating of the Battery

We used battery listed below table for our standard.

Brand	Battery model	voltage	CCA	L(in)	W(in)	H(in)	Weight(lbs)
VARTA	6-QW-38LTHD	DC12V	310	7.76	5.04	7.95	22.7
VARTA	6-QW-54HD	DC12V	410	11.4	6.85	6.65	36.8
VARTA	L2-400MF	DC12V	640	9.49	6.85	7.4	34.8
VARTA	6-QW-80L	DC12V	622	12	6.77	7.99	47.4

Table 9.1 Battery for starting

9.7. Battery Connection

When preparing to start the genset, place the battery onto battery support located on the base frame. Next, connect the battery cable to the battery. First connect positive pole, then connect the negative pole. When removing the battery, always remove the negative battery cable first.

10. ELECTRICAL CONNECTION

Only full qualified and experienced electrical technicians should carry out electrical installation, service, and repair work.

Warning:

Make electrical connections in compliance with all relevant Electrical Codes, Standards, or other requirements.

10.1. Cabling

Due to movement of generating sets on their vibration mounts, the electrical connection to the set should be made with flexible cable.

The cable must be suitable for the output voltage of the generating set and the rated current of the set. In determining the size, allowances should be made for ambient temperature, method of installation, proximity of other cables. etc.

All connections should be carefully checked for integrity. The current carrying capacity of power cables are given in table 10.1 and the cable cross sections which must be used according to the generating set power are given in table 10.2. On the other hand, there is one more important point to consider while selecting cable cross sections. If the distance between load and generator is too long, the voltage drop on the load side may be too high at the transient current duration. The voltage drop across a cable can be determined as follows:

$$e = \frac{x L x I x (R \cos\phi + \sin\phi)}{1000}$$

e = Voltage drop (V)

I = Rated current (A)

L = Length of conductors (m)

R = Resistance (Ω /km to VDE 0102)

X = Reactance (Ω /km to VDE 0102)

10.2. . Protection

The cables connecting the generating set with the distribution system are protected by means of a circuit breaker to automatically disconnect the set in case of overload or short circuit.

10.3. . Loading

When planning the electrical distribution system, it is important to ensure that a balanced load is presented to the generating set. If loading on one phase is substantially higher than the other phases, it will cause over heating in the alternator windings, imbalance in the phase output voltage, and possible damage to sensitive 3-phase equipment connected to the system. Ensure that no individual phase current exceeds the current rating of the generating set. For connection to existing distribution system, it may be necessary to reorganize the distribution system to ensure these loading factors are met.

10.4. . Power Factor

The power factor (Cosφ) of the connected load should be determined. Power factors below 0.8 lagging (inductive) can overload the generator. The set will provide its kilowatt rating and operate satisfactorily from 0.8 lagging to unity power factor (1.0) Particular attention must be given to installations with power factor correction equipment such as capacitors to ensure that a leading power factor is never present. This will lead to voltage instability and may result in voltage surges that may damage equipment. Generally, whenever the generating set is supplying the load, any power factor correction equipment should be switched off.

10.5. Grounding/Earthing Requirements:

The frame of the generating set must be connected to an earth ground. Since the set is mounted on vibration isolators, the ground connection must be flexible to avoid possible breakage due to vibration. Ground connection cables or straps should have at least full load current carrying capacity and meet applicable regulations.

10.6. Insulation Test:

Before starting the generating set after installation, test the insulation resistance of the windings. The Automatic Voltage Regulator (AVR) should be disconnected and the rotating diodes either shorted out with temporary links or disconnected. Any control wiring must also be disconnected. A 500V Megger or similar instrument should be used. Disconnect any grounding conductors connected between neutral and earth and meg an output terminal to earth.

10.7 Fuse ratings and instructions

Ampere Rating	Voltage Rating	Nominal Resistance Cold Ohms	Nominal Melting Pt A ² Sec.	Used for
2	250	0.076	1.87	Gen. set controller
3.15	250	0.037	6.7	Canopy light
6	250	0.014	12.3	Voltage Sensing



User can replace the fuses without tools, when replacing the fuses, it must be the same ampere Rating (UL, RC)

Genset		Standby load Current at 480V (single 277V)	Cable section Y V V Single core for each phase	N phase wiring harness (AWG)	Terminal Size	N	install tool
Model	Standby Power (KW)					(A)	
APD-ULP9	9	13.5	13	13	N/A	N/A	N/A
APD-ULP13	13	19.5	13	13	N/A	N/A	N/A
APD-ULP20	20	30.1	9	9	N/A	N/A	N/A
APD-ULP28	28	42	6	6	N/A	M8	14mm spanner
APD-ULP30	30	45	6	6	N/A	M8	14mm spanner
APD-ULJ30	30	45	6	6	N/A	M8	14mm spanner
APD-ULJ40	40	60	10	10	N/A	M8	14mm spanner
APD-ULJ55	55	83	2	2	N/A	M8	14mm spanner
APD-ULP56	56	84	2	2	N/A	M8	14mm spanner
APD-ULJ65	65	98	2	2	N/A	M8	14mm spanner
APD-ULP65	65	98	2	2	N/A	M8	14mm spanner
APD-ULJ80	80	120	2	2	N/A	M8	14mm spanner
APD-ULP82	82	123	2	2	N/A	M8	14mm spanner
APD-ULJ100	100	150	1/0	1/0	N/A	M12	17mm spanner
APD-ULP100	100	150	1/0	1/0	N/A	M12	19mm spanner
APD-ULJ125	125	188	2/0	2/0	N/A	M12	19mm spanner
APD-ULJ150	150	226	2/0	2/0	N/A	M12	19mm spanner
APD-ULP150	150	226	2/0	2/0	N/A	M12	19mm spanner
APD-ULP178	178	268	3/0	2/0	N/A	M12	19mm spanner
APD-ULJ180	180	271	3/0	2/0	N/A	M12	19mm spanner
APD-ULJ200	200	301	2*2/0	2/0	N/A	M12	19mm spanner
APD-ULP200	200	301	2*2/0	2/0	N/A	M12	19mm spanner
APD-ULP250	250	376	2*2/0	2/0	N/A	M12	19mm spanner
APD-ULJ250	250	376	2*2/0	2/0	N/A	M12	19mm spanner
APD-ULJ275	275	414	2*2/0	2/0	N/A	M12	19mm spanner
APD-ULJ300	300	451	2*3/0	3/0	N/A	M12	19mm spanner
APD-ULP300	300	451	2*3/0	3/0	N/A	M12	19mm spanner
APD-ULJ350	350	526	2*3/0	3/0	N/A	M12	19mm spanner
APD-ULP350	350	526	2*3/0	3/0	N/A	M12	19mm spanner
APD-ULJ400	400	601	3*3/0	3/0	N/A	M12	19mm spanner
APD-ULP400	400	601	3*3/0	3/0	N/A	M12	19mm spanner
APD-ULP461	461	693	3*3/0	2*3/0	M12	M12	19mm spanner
APD-ULJ500	500	752	3*3/0	2*3/0	M12	M12	19mm spanner
APD-ULP512	512	770	3*3/0	2*3/0	M12	M12	19mm spanner
APD-ULP565	565	850	3*4/0	2*4/0	M12	M12	19mm spanner
APD-ULP611	611	919	3*4/0	2*4/0	M12	M12	19mm spanner
APD-ULM800	800	1203	4*4/0	2*4/0	M12	M12	19mm spanner
APD-ULM1000	1000	1504	5*4/0	3*4/0	M12	M12	19mm spanner
APD-ULV250	250	376	2*2/0	2/0	N/A	M12	19mm spanner
APD-ULV300	300	451	2*3/0	3/0	N/A	M12	19mm spanner

APD-ULV350	350	526	2*3/0	3/0	N/A	M12	19mm spanner
APD-ULV400	400	601	3*3/0	3/0	N/A	M12	19mm spanner
APD-ULV450	450	677	3*3/0	2*3/0	M12	M12	19mm spanner
APD-ULV500	500	752	3*3/0	2*3/0	M12	M12	19mm spanner
APD-ULV550	550	827	3*4/0	2*4/0	M12	M12	19mm spanner
APD-ULV600	600	902	3*4/0	2*4/0	M12	M12	19mm spanner

Genset		Standby load Current at 240V (single 120V)	Cable section Y V V Single core for each phase	N phase wiring harness (AWG)	Terminal Size	N	install tool
Model	StandBy Power (KW)	(A)	(AWG)			connection bolt size	
APD-ULP9	9	27.1	13	13	N/A	N/A	N/A
APD-ULP13	13	39.1	11	11	N/A	N/A	N/A
APD-ULP20	20	60.1	7	7	N/A	N/A	N/A
APD-ULP28	28	84	5	5	N/A	M8	14mm spanner
APD-ULP30	30	90	5	5	N/A	M8	14mm spanner
APD-ULJ30	30	90	5	5	N/A	M8	14mm spanner
APD-ULJ40	40	120	2	2	N/A	M8	14mm spanner
APD-ULJ55	55	165	1/0	1/0	N/A	M8	14mm spanner
APD-ULP56	56	168	1/0	1/0	N/A	M8	14mm spanner
APD-ULJ65	65	196	2/0	2/0	N/A	M8	14mm spanner
APD-ULP65	65	196	2/0	2/0	N/A	M8	14mm spanner
APD-ULJ80	80	241	3/0	3/0	N/A	M8	14mm spanner
APD-ULP82	82	247	3/0	3/0	N/A	M8	14mm spanner
APD-ULJ100	100	301	2*2/0	2/0	N/A	M12	17mm spanner
APD-ULP100	100	301	2*2/0	2/0	N/A	M12	19mm spanner
APD-ULJ125	125	376	2*2/0	2/0	N/A	M12	19mm spanner
APD-ULJ150	150	451	2*2/0	2/0	N/A	M12	19mm spanner
APD-ULP150	150	451	2*2/0	2/0	N/A	M12	19mm spanner
APD-ULP178	178	535	2*3/0	3/0	N/A	M12	19mm spanner
APD-ULJ180	180	541	2*3/0	3/0	N/A	M12	19mm spanner
APD-ULP200	200	601	3*3/0	2*3/0	N/A	M12	19mm spanner
APD-ULJ200	200	601	3*3/0	2*3/0	N/A	M12	19mm spanner
APD-ULP250	250	752	3*3/0	2*3/0	N/A	M12	19mm spanner
APD-ULJ250	250	752	3*3/0	2*3/0	N/A	M12	19mm spanner
APD-ULJ275	275	827	3*3/0	2*3/0	N/A	M12	19mm spanner
APD-ULJ300	300	902	3*4/0	2*4/0	N/A	M12	19mm spanner
APD-ULP300	300	902	3*4/0	2*4/0	N/A	M12	19mm spanner
APD-ULJ350	350	1053	4*4/0	2*4/0	N/A	M12	19mm spanner
APD-ULP350	350	1053	4*4/0	2*4/0	N/A	M12	19mm spanner
APD-ULJ400	400	1203	4*4/0	2*4/0	N/A	M12	19mm spanner
APD-ULP400	400	1203	4*4/0	2*4/0	N/A	M12	19mm spanner
APD-ULP461	461	1386	5*4/0	3*4/0	M12	M12	19mm spanner
APD-ULJ500	500	1504	5*4/0	3*4/0	M12	M12	19mm spanner
APD-ULP512	512	1540	5*4/0	3*4/0	M12	M12	19mm spanner

APD-ULP565	565	1699	6*4/0	3*4/0	M12	M12	19mm spanner
APD-ULP611	611	1837	6*4/0	3*4/0	M12	M12	19mm spanner
APD-ULM800	800	2407	8*4/0	4*4/0	M12	M12	19mm spanner
APD-ULM1000	1000	3007	6*500Kcmil	3*500Kcmil	M12	M12	19mm spanner
APD-ULV250	250	752	3*3/0	2*3/0	N/A	M12	19mm spanner
APD-ULV300	300	902	3*4/0	2*4/0	N/A	M12	19mm spanner
APD-ULV350	350	1053	4*4/0	2*4/0	N/A	M12	19mm spanner
APD-ULV400	400	1203	4*4/0	2*4/0	N/A	M12	19mm spanner
APD-ULV450	450	1353	5*4/0	3*4/0	M12	M12	19mm spanner
APD-ULV500	500	1504	5*4/0	3*4/0	M12	M12	19mm spanner
APD-ULV550	550	1654	5*4/0	3*4/0	M12	M12	19mm spanner
APD-ULV600	600	1804	5*4/0	3*4/0	M12	M12	19mm spanner

Genset		Standby load Current at (single 240V (single 120V)	Cable section Y V V Single core for each phase	N phase wiring harness (AWG)	Terminal Size	N	install tool
Model	StandBy Power (KW)	(A)	(AWG)			connection bolt size	
APD-ULP9	9	37.5	9	9	N/A	N/A	N/A
APD-ULP13	13	54.2	3	3	N/A	N/A	N/A
APD-ULP20	20	83.3	3	3	N/A	M10	17mm spanner
APD-ULP28	28	116.7	2	2	N/A	M10	17mm spanner
APD-ULP30	30	125	2	2	N/A	M10	17mm spanner
APD-ULJ30	30	125	2	2	N/A	M10	19mm spanner
APD-ULJ40	40	167	1/0	1/0	N/A	M12	19mm spanner
APD-ULJ55	55	208	2/0	2/0	N/A	M12	19mm spanner
APD-ULP56	56	220.8	3/0	3/0	N/A	M12	19mm spanner
APD-ULJ65	65	250	3/0	3/0	N/A	M12	19mm spanner
APD-ULP65	65	258.3	3/0	3/0	N/A	M12	19mm spanner
APD-ULJ80	80	333.3	2*1/0	1/0	N/A	M12	19mm spanner
APD-ULP82	82	333.3	2*1/0	1/0	N/A	M12	19mm spanner
APD-ULJ100	100	400	2*2/0	2/0	N/A	M12	19mm spanner
APD-ULP100	100	404.2	2*2/0	2/0	N/A	M12	19mm spanner
APD-ULJ125	125	521	2*2/0	2/0	N/A	M12	19mm spanner
APD-ULJ150	150	625	2*3/0	3/0	N/A	M12	19mm spanner
APD-ULP150	150	625	2*3/0	3/0	N/A	M12	19mm spanner

Table 10.2 Recommended single core cable cross section at 40°C ambient

The insulation resistance should be in excess of 1 MΩ to earth. Should the insulation resistance be less than 1 MΩ, the windings must be dried out.

11. ACOUSTIC SILENCING

Controlling the amount of noise output by a generating set is becoming very important in most installations. There is a variety of components available to control the noise level.

WARNING

! Ear protection must be worn when operating or working around an operating generating set.

11.1. Exhaust Silencers:

As discussed in Section 3.10 the exhaust silencer will decrease sound level from the engine.

11.2. Canopies:

Section 4.2 discusses sound attenuating canopies that lower the noise level of the entire generating set.

11.3. Other Sound Attenuation:

For installation in buildings, there are other types of equipment such as acoustic louvers, splitter vents, and fan silencers as well as sound absorbing wall coverings that can be used to reduce the noise levels of generating sets.

12. STORAGE

Long-term storage can have detrimental effects on both the engine and alternator. These effects can be minimized by properly preparing and storing the generating set.

12.1. Engine Storage:

The engine should be put through an engine “preservation” procedure that includes cleaning the engine and replacing all the fluids with new fluids or preserving fluids.

12.2. Alternator Storage:

When an alternator is in storage, moisture tends to condense in the windings. To minimize condensation, store the generating set in a dry storage area. If possible use space heaters to keep the windings dry. After removing the generating set from storage, perform an insulation check as discussed in Section 10.6.

12.3. Battery Storage:

While the battery is stored, it should receive a refreshing charge every 8 weeks up to a fully charged condition.

13. GENERAL PRECAUTIONS AND CONTROLS WHICH MUST BE DONE BEFORE STARTING UP THE GENERATING SET.

- Make a general visual inspection on the engine and alternator. Check to see if there are any breaks, cracks, indentation, leaks, or looseness. If any of these exist, DO NOT operate the generating set before making the necessary repairs.
- Take out foreign materials such as keys, tools, cleaning wool, papers, etc. on the engine and the alternator.
- Check the fuel level in day tank. Refill with fuel if it is low.
- Check the oil level on the dipstick. Refill with an appropriate oil if it is low. Oil level should normally be close to the maximum level line.
- Look at the water level by opening the radiator tap. If it is inadequate, add more water. Water level should be approximately 1-/8" lower than the water filling neck.
- Engine cooling water must include antifreeze according to the coolest weather conditions in the area.
- A mixture of 50% antifreeze and 50% water provides a good protection in all areas.
- Inspect the radiator air outlet hood, open if clogged, and clear away all obstructions in front of the air outlet.
- Check the air filter gauge. Clean or replace the air filter, if necessary.
- Make sure that opening is not obstructed.
- Make sure that the generating set can easily take air from the environment.
- Check the battery connection cables. Take care to tighten any loose battery terminals with the proper size tool and cover with any battery terminal coating substance. In order to keep clean and avoid oxidation and corrosion of terminals.
- Open the battery caps and check the liquid level in the cells for maintenance type battery. Add distilled water, if necessary, so as to be approximately 3/8" higher than the separation. Never fill the cells with tap water, acid water or acid.
- Ensure that the circuit breaker outlet switch is in the OFF position.
- Make sure that the emergency stop button is not pressed.

14. GENERATING SET CONTROL SYSTEMS (DSE 7320 MKII)

To control and monitor the generating set, an electronic control system has been used. The DSE7320 MKII control system is fitted to all generating sets. This control panel provides a means of starting and stopping the generating set, monitoring its operation and output, and automatically shutting down the set in the event of critical condition arising such as low oil pressure or high engine temperature.

14.1 DSE7320 MKII, Control System

The DSE7320 MKII is an Auto Start Control Module and an Auto Mains (Utility) Failure Control Module suitable for a wide variety of single, diesel or gas, gen-set applications. Monitoring an extensive number of engine parameters, the modules will display warnings, shutdown and engine status information on the back-lit LCD screen, illuminated LEDs, remote PC and via SMS text alerts (with external modem). The DSE7320 MKII will also monitor the mains (utility) supply. The modules include USB, RS232 and RS485 ports as well as dedicated DSENet® terminals for system expansion

The module is compatible with electronic (CAN) and non-electronic (magnetic pick-up/alternator sensing) engines and offer an extensive number of flexible inputs, outputs and extensive engine protections so the system can be easily adapted to meet the most demanding industry requirements.

The extensive list of features includes enhanced event and performance monitoring, remote communications & PLC functionality. Dual mutual standby is now available on both the DSE7310 MKII & DSE7320 MKII using RS232 or RS485 communications. This provides for a simpler and more convenient installation with more advanced features such as true engine hours balancing.

The modules can be easily configured using the DSE Configuration Suite PC software. Selected front panel editing is also available.

14.1.1 Description of Controls

CAUTION: The module may instruct an engine start event due to external influences. Therefore, it is possible for the engine to start at any time without warning. Prior to performing any maintenance on the system, it is recommended that steps are taken to remove the battery and isolate supplies.



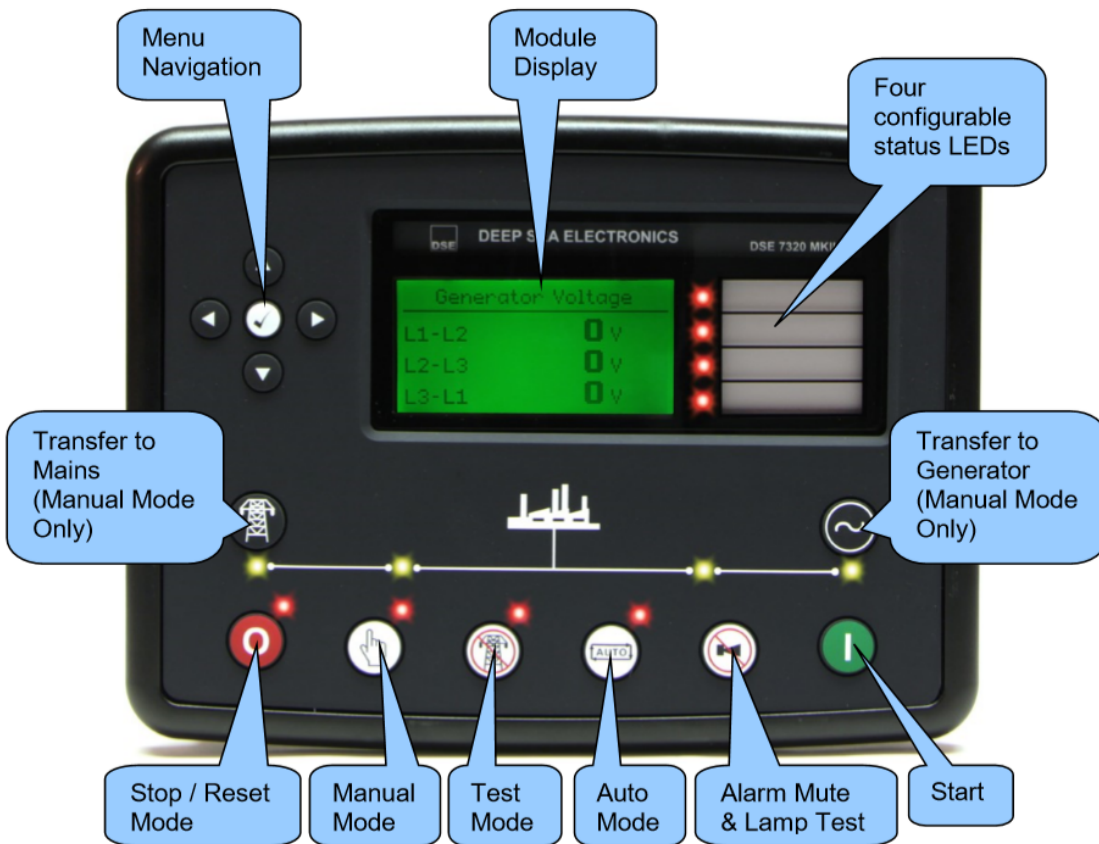

NOTE: The following descriptions detail the sequences followed by a module containing the standard 'factory configuration'. Always refer to your configuration source for the exact sequences and timers observed by any particular module in the field.

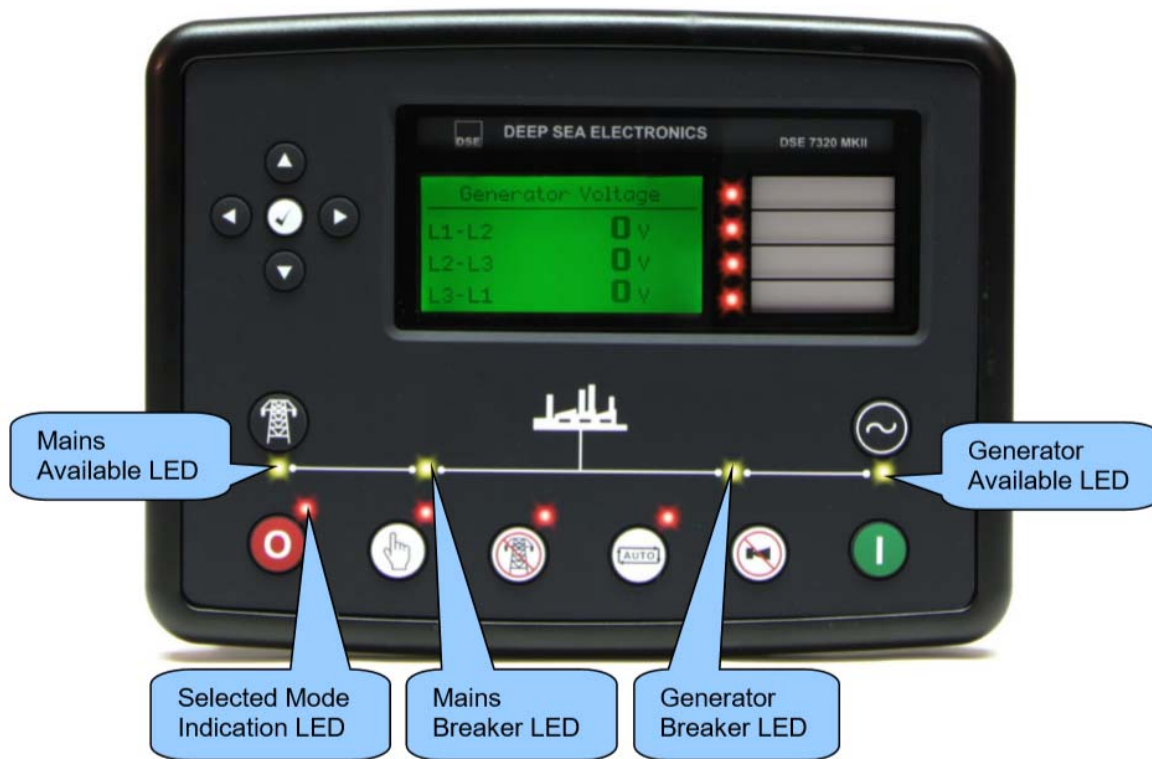









Control of the module is via push buttons mounted on the front of the module with **Stop/Reset Mode** (⏻), **Manual Mode** (👉), **Test Mode** (🔧) (DSE7320 MKII Only), **Auto Mode** (AUTO) and **Start** (▶) functions. For normal operation, these are the only controls which need to be operated. Details of their operation are provided later in this document.













14.1.2 Control Push Button

Icon	Description
	<p>Stop / Reset Mode</p> <p>This button places the module into its Stop/Reset Mode . This clears any alarm conditions for which the triggering criteria has been removed. If the engine is running and the module is put into Stop/Reset Mode , the module automatically instructs the generator off load ('Close Generator Output' becomes <i>inactive (if used on)</i>) and place the mains on load ('Close Mains Output' becomes <i>active (DSE7320 MKII)</i>). The fuel supply de-energises and the engine comes to a standstill. Should any form of <i>start signal</i> be present when in Stop/Reset Mode  the generator remains at rest</p>

	<p>Manual Mode</p> <p>This button places the module into its Manual Mode . Once in Manual Mode , the module responds to the Start  button to start the generator and run it off load.</p> <p>To place the generator on load, use the Transfer to Generator  button. The module automatically instructs the changeover device to take the mains off load ('Close Mains Output' becomes inactive (if used on DSE7320 MKII)) and place the generator on load ('Close Generator Output' becomes active (if used)). To place the generator off load, use the Transfer to Mains  or Open Generator  buttons. The module automatically instructs the changeover device to take the generator off load ('Close Generator Output' becomes inactive (if used on)) and place the mains on load ('Close Mains Output' becomes active (DSE7320 MKII)). Additional digital inputs can be assigned to perform these functions.</p> <p>If the engine is running off-load in Manual Mode  and on load signal becomes active, the module automatically instructs the changeover device the changeover device to take the mains off load ('Close Mains Output' becomes inactive (if used on DSE7320 MKII)) and place the generator on load ('Close Generator Output' becomes active (if used)). Upon removal of the on load signal, the generator remains on load until either selection of the Stop/Reset Mode  or Auto Mode .</p>
---	--

	<p>Test Mode (DSE7320 MKII Only)</p> <p>This button places the module into its Test Mode . Once in Test Mode , the module responds to the Start  button to start the generator.</p> <p>Once the set has started and becomes available, it is automatically placed on load (Close Mains Output becomes inactive (if used on DSE7320 MKII) and Close Generator Output becomes active (if used)).</p> <p>The generator remains on load until either the Stop/Reset Mode  or Auto Mode  is selected.</p>
---	---

Icon	Description
	<p>Auto Mode</p> <p>This button places the module into its Auto Mode . This mode allows the module to control the function of the generator automatically. The module monitors numerous start requests and when one has been made, the set is automatically started. Once the generator is available, the mains is taken off load ('Close Mains Output' becomes inactive (if used on DSE7320 MKII)) and the generator is placed on load ('Close Generator Output' becomes active (if used)).</p> <p>Upon removal of the starting signal, the module starts the <i>Return Delay Timer</i> and once expired, takes the generator off load ('Close Generator Output' becomes inactive (if used on)) and place the mains on load ('Close Mains Output' becomes active (DSE7320 MKII)). The generator then continues to run for the duration of the <i>Cooling Timer</i> until it stops. The module then waits for the next start event.</p>







Alarm Mute / Lamp Test

This button silences the audible alarm in the controller, de-activates the *Audible Alarm* output (if configured) and illuminates all of the LEDs on the module's fascia as a lamp test function.



Start

This button is only active in the **Stop/Reset Mode** , **Manual Mode**  and **Test Mode** .







Pressing the **Start**  button in **Stop/Reset Mode**  powers up the engine's ECU but does not start the engine. This can be used to check the status of the CAN communication and to prime the fuel system.





Pressing the **Start**  button in **Manual Mode**  or **Test Mode**  starts the generator and runs it off load in **Manual Mode**  or on load in **Test Mode** .









Menu Navigation

Used for navigating the instrumentation, event log and configuration screens.

Icon	Description
	<p>The Transfer to Generator  button controls the operation of the generator load switch is only active in the Manual Mode  once the generator is available.</p> <p>'Normal' Breaker Button Control</p> <p>Pressing the Transfer to Generator  button when the Generator is available and off load, the Mains load switch is opened ('Close Mains' becomes inactive) and the Generator load switch is closed ('Close Generator' becomes active).</p> <p>Further presses of the Transfer to Generator  button have no effect.</p> <p>'Alternative' Breaker Button Control</p> <p>Pressing the Transfer to Generator  button when the Generator is available and off load, the Mains load switch is opened ('Close Mains' becomes inactive) and the Generator load switch is closed ('Close Generator' becomes active).</p> <p>Further presses of the Transfer to Generator  button opens and closes the Generator load switch ('Close Generator' changes state) and leaves the Mains load switch in the open position ('Close Mains' remains inactive).</p>

	<p>Open Generator (DSE7310 MKII Only)</p> <p>The Open Generator  button is only active in the Manual Mode  and allows the operator to open the generator load switch. Pressing the Open Generator  button when the Generator is on load, the generator load switch is opened ('Close Generator' becomes inactive). Further presses of the Open Generator  button have no effect.</p>
---	--



	<p>Transfer To Mains (DSE7320 MKII Only)</p> <p>The Transfer to Mains  button controls the operation of the mains load switch and is only active in Manual Mode .</p> <p>'Normal' Breaker Button Control</p> <p>Pressing the Transfer to Mains  button when the Mains is available and off load, the generator switch is opened ('Close Generator' becomes inactive) and the mains switch is closed ('Close Mains' becomes active). Further presses of the Transfer to Mains  button have no effect.</p> <p>'Alternative' Breaker Button Control</p> <p>Pressing the Transfer to Mains  button when the Mains is available and off load, the generator load switch is opened ('Close Generator' becomes inactive) and the mains load switch is closed ('Close Mains' becomes active). Further presses of the Transfer to Mains  button opens and closes the mains load switch ('Close Mains' changes state) and leaves the generator load switch in the open position ('Close Generator' remains inactive).</p>
---	--

14.1.3 Viewing Instrument Pages

It is possible to scroll to display the different pages of information by repeatedly operating the

Next & Previous Page  buttons.

Example

Status  **Generator**  **Mains** 

And so on until the desired page is reached. Further presses of the **Next Page Button**  returns the Status page.

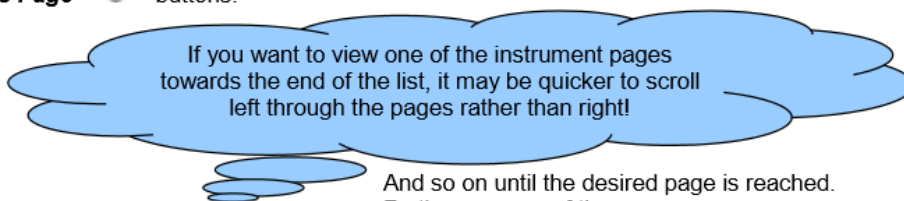

The complete order and contents of each information page are given in the following sections

Once selected, the page remains on the LCD display until the user selects a different page, or after an extended period of inactivity (**LCD Page Timer**), the module reverts to the status display.

If no buttons are pressed upon entering an instrumentation page, the instruments displayed are automatically subject to the setting of the **LCD Scroll Timer**.

The **LCD Page** and **LCD Scroll** timers are configurable using the DSE Configuration Suite Software or by using the Front Panel Editor.

Alternatively, to scroll manually through all instruments on the currently selected page, press the

Instrumentation Scroll  buttons. The 'auto scroll' is disabled.

To re-enable 'auto scroll' press the **Instrumentation Scroll**  buttons to scroll to the 'title' of the instrumentation page (ie Mains). A short time later (the duration of the *LCD Scroll Timer*), the instrumentation display begins to auto scroll.

When scrolling manually, the display automatically returns to the Status page if no buttons are pressed for the duration of the configurable *LCD Page Timer*.

If an alarm becomes active while viewing the status page, the display shows the Alarms page to draw the operator's attention to the alarm condition.

15. GENERAL PRECAUTIONS AND CONTROLS WHICH MUST BE DONE AFTER STARTING UP THE GENERATING SET

- Check for any abnormal noise or vibration on the generating set.
- Check to see if the exhaust system has any leakage.
- Monitor the generating set operation by means of the control module LCD display. Check the engine temperature and oil pressure Oil pressure must reach the normal value 10 seconds after the generating set begins operation.
- Monitor the generating set outlet voltage and frequency by means of the control module LCD display. Check the voltage to ensure that the phase-to-phase voltage is 480V and the phase to neutral voltage is 277V Check that the frequency is –62 - 64Hz on generating sets with mechanical governors and 60Hz on generating sets with electronic governors.
- If an engine block water heater is not available, run the generating set at no-load for 8 minutes and when the engine is at normal operating temperature, apply the load. For manual models, apply load to the generating set as follows:
 - Set the alternator outlet circuit breaker on the panel to the ON position.
 - Set the load circuit breakers (or fuses) on the distribution panel to ON position one by one. By performing this step, the generating set cannot be suddenly put under full load. The engine may stall or the alternator winding insulation burning can occur.
 - Set the alternator outlet circuit breaker on the circuit to OFF position before stopping the generating set.
- Continue to run the unloaded engine for purpose of cooling period for 5 minutes before shutting genset down.
- Never operate the generating set before removing faults if any are present.

16. CONTROL PANELS

Control, supervision and protection panels are mounted on the generator base frame.

There are many fuses inside of the control panel for protection. If a fuse blows, check all related wires. After the problem is resolved, replace the fuse with the appropriate size fuse. DO NOT use a fuse of size other than what was originally in the control panel.

16.1. . Control System DSE7320 MKII

Equipment:

DSE 7320 MKII, Automatic Mains Failure module

- Static battery charger
- Emergency stop push

button DSE 7320 MKII Module

Features

- To monitor AC main supply
- Automatically controls generating set start and stop
- Provides a signal to the Automatic transfer Switch

(ATS)

- Scrolling digital LCD display
- Remote communication via RS232 port or RS 485 mod bus output.
- Event logging of shutdown alarms.
- Front panel configuration of timers and alarm trip points
- Easy push button control
- STOP/RESET – MANUAL – AUTO – TEST – START

Metering Via LCD Display

- Generator Volts (L-L / L - N)
- Generator Ampere (L1, L2, L3)
- Generator Frequency (Hz)
- Generator kVA
- Generator kW
- Generator Cos
- Mains Volt (L - L / L - N)
- Mains Frequency (Hz)
- Engine cooling temperature (°C & °F)
- Engine oil pressure (PSI & Bar)
- Engine speed (RPM)
- Engine hours run
- Plant battery volt

Multiple Alarms

- Under / Over generator volts; Pre-alarm and Shutdown
- Under / Over generator frequency Pre-alarm and Shutdown
- Under / Over mains volts
- Under / Over mains frequency
- Over current; Shutdown
- Low oil pressure; Pre-alarm and Shutdown
- High engine temperature; Pre-alarm and Shutdown
- Under/over speed; Shutdown
- Low coolant level; Shutdown
- Fail to start; Shutdown
- Fail to stop; Warning
- Low/High battery volts; Warning
- Charge fail; Warning
- Emergency stop; Shutdown
- Can Data Fail; Shutdown
- Can ECU Fail; Pre-Alarm and Shutdown

The Event Log

7320 MKII control module maintains a log the last 15 shutdown alarms to enable the operator or engineer to view the past alarms history.

17. THE PLACEMENT AND INTALLATION OF AUTOMATIC TRANSFER SWITCH (ATS)

The placement of the transfer switch and its mountings:

- Position the transfer switch near the emergency power panel.
- Locate the transfer switch in a place where it is clean, not over- heated, and good ventilation is present. If the environment temperature is above 104 °F, breakers will open more easily. There must be enough work space around the transfer switch.
- A breaker may be installed between the generating set and the transfer switch, but it is not required. Current from the generating set must be distributed as equally to the three phases as possible.
- Current from one phase should not exceed the nominal current.
- If the transfer switch panel is apart from the generating set, the ATS must be placed as close as possible to the distributor panel.
- In this case, power cables are drawn from the generating set, the main panel, and emergency power panel. Furthermore, control cables must be drawn from the generating set control panel.

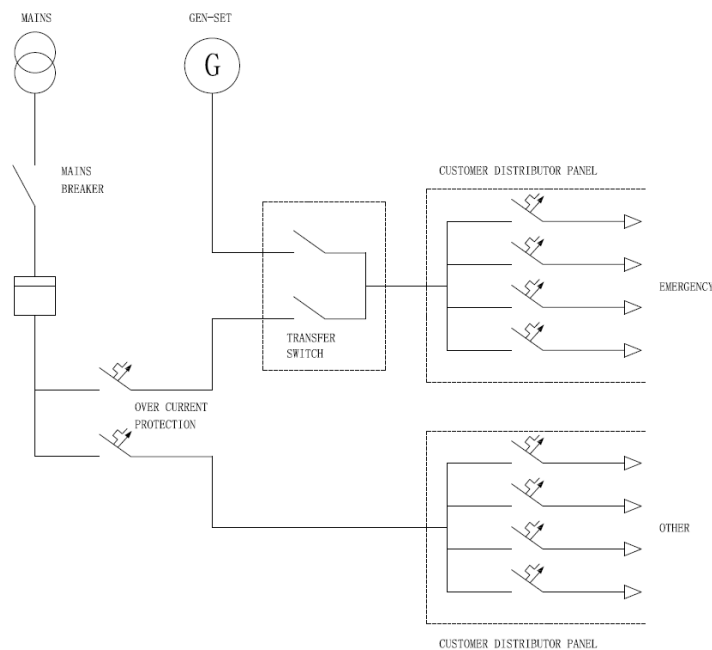

Figure 17.1 Typical emergency power system installation

18. . ENGINE TROUBLESHOOTING

The starter motor turns the engine too slowly:

- Battery capacity too low
- Bad electrical connection
- Faulty in starter motor
- Wrong grade of lubricating oil

The engine does not start or difficult to start:

- Starter motor turns engine too slowly
- Fuel tank empty
- Faulty in fuel control solenoid
- Restriction in a fuel pipe
- Faulty in fuel lift pump
- Dirty fuel filter element
- Air in fuel system
- Faulty in atomizers
- Cold start systems used incorrectly
- Fault in cold start system
- Restriction in fuel tank vent
- Wrong type or grade of fuel used
- Restriction in exhaust pipe

Not enough power:

- Restriction in a fuel pipe
- Faulty in fuel lift pump
- Dirty fuel filter element
- Air in fuel system
- Restriction air filter/cleaner or induction system
- Restriction in exhaust pipe
- Fault in atomizers or atomizers of an incorrect type
- Restriction in fuel tank vent
- Wrong type or grade of fuel used
- Restricted movement of engine speed control
- Engine temperature is too high or low

Misfire

- Restriction in a fuel pipe
- Faulty in fuel lift pump
- Dirty fuel filter element
- Air in fuel system
- Fault in atomizers or atomizers of an incorrect type

- Fault in cold start system
- Engine temperature is too high
- Incorrect valve tip clearances

The pressure of the lubrication oil is too low:

- Wrong grade of lubrication
- Not enough lubrication oil in sump
- Defective gauge
- Dirty lubrication oil filter element

High fuel consumption:

- Restriction air filter/cleaner or induction system
- Fault in atomizers or atomizers of an incorrect type
- Fault in cold start system
- Wrong type or grade of fuel used
- Restricted movement of engine speed control
- Restriction in exhaust pipe
- Engine temperature is too low
- Incorrect valve tip clearances

Black exhaust smoke:

- Restriction air filter/ cleaner or induction system
- Fault in atomizers or atomizers of an incorrect type
- Fault in cold start system
- Wrong type or grade of fuel used
- Restriction in exhaust pipe
- Engine temperature is too low
- In correct valve tip clearances
- Engine over load

Blue or white exhaust smoke

- Wrong grade of lubrication
- Fault in cold start system
- Engine temperature is too low

The engine knocks:

- Faulty in fuel lift pump
- Fault in atomizers or atomizers of an incorrect type
- Wrong type or grade of fuel used
- Fault in cold start system
- Engine temperature is too high
- Incorrect valve tip clearances

The engine runs erratically:

- Fault in fuel control
- Restriction in a fuel system
- Fault in fuel lift pump
- Dirty fuel filter element
- Restriction air filter/cleaner or induction system
- Air in fuel system
- Fault in atomizers or atomizers of an incorrect type
- Fault in cold start system
- Restriction in fuel tank vent
- Restricted movement of engine speed control
- Engine temperature is too high
- In correct valve tip clearances

Vibration:

- Fault in atomizers or atomizers of an incorrect type
- Restricted movement of engine speed control
- Engine temperature is too high
- Fan damaged
- Fault in engine mounting or flywheel housing
- The engine temperature is too high:
- Restriction air filter/cleaner or induction system
- Fault in atomizers or atomizers of an incorrect type
- Fault in cold start system
- Restriction in exhaust pipe
- Fan damaged
- Too much lubrication oil in pump
- Restriction in air or water passage of radiator
- Insufficient coolant system

Crankcase pressure:

- Restriction in breather pipe
- Vacuum pipe leaks or fault in exhauster

Bad compression:

- Restriction air filter/cleaner or induction system
- Incorrect valve tip clearances

The engine starts and stops:

- Dirty fuel filter element
- Restriction air filter/cleaner or induction system
- Air in fuel system

The engine shuts down after approximately 15 seconds:

19. GENERAL PRECAUTIONS ABOUT WARRANTY

DEAR AKSA GENERATING SET OPERATOR,

PLEASE TAKE CARE TO THE FOLLOWING IN ORDER TO PREVENT THE GENERATING SET WARRANTY FROM BECOMING INVALID PRIOR TO THE TERMINATION OF THE WARRANTY PERIOD AND TO ENSURE TROUBLE-FREE OPERATION OF THE GENERATING SET.

MAINTENANCE AND REPAIR WORKS WILL NOT BE COVERED BY THE WARRANTY UNLESS THE WARRANTY CERTIFICATE, INVOICE, OR DELIVERY CERTIFICATE OF THE GENERATING SET IS SUBMITTED.

THE WARRANTY OF THE GENERATING SET WILL BECOME INVALID IN THE CASE OF ANY INTERVENTION OF ANY PERSON OTHER THAN AUTHORIZED AKSA SERVICES OR BY PRIOR WRITTEN APPROVAL FROM AKSA POWER GENERATION ON THE GENERATING SET FOR ANY REASON.

CONTROL AND MAINTENANCE WORK INDICATED IN THE PERIODICAL MAINTENANCE SCHEDULE AND THE OPERATING MANUAL MUST BE CARRIED OUT COMPLETELY AND TIMELY. THE FAILURES DUE TO INCOMPLETE OR UNTIMELY MAINTENANCE ARE NOT COVERED BY THE WARRANTY.

GENERATING SET SHOULD BE MOUNTED AS INDICATED IN THE OPERATING MANUAL OTHERWISE; THE PROBLEMS WHICH ARE LIKELY TO OCCUR WILL NOT BE COVERED BY THE WARRANTY. THE CUSTOMER IS RESPONSIBLE FOR THE FAILURES WHICH ARE LIKELY TO OCCUR IN THE CASE THAT THE DIESEL OIL USED CONTAINS DIRT OR WATER.

THE OIL TYPE INDICATED IN THE OPERATING MANUAL SHOULD BE USED IN THE ENGINE. OTHERWISE, THE FAILURES WHICH ARE LIKELY TO OCCUR WILL NOT BE COVERED BY THE WARRANTY.

BATTERIES WILL NOT BE COVERED BY THE WARRANTY IF THEY ARE SUBJECTED TO BREAKAGE, EXCESSIVE ACID FILL, OR HARDENING BY LEAVING UNCHARGED.

ON MANUAL GENERATING SETS, NEVER START OR STOP THE DIESEL ENGINE WHEN THE GENERATING SET IS UNDER LOAD. ENGINE SHOULD BE STARTED AND STOPPED AFTER LOAD IS DISCONNECTED AND THE GENERATING SET IS AT IDLE CONDITION. OTHERWISE, THE VALVES CAN BE SEIZED, THE VOLTAGE REGULATOR, TRANSFORMER AND DIODES CAN BE BROKEN. THESE CONDITIONS ARE NOT COVERED BY THE WARRANTY.

OUR COMPANY DOES NOT TAKE THE RESPONSIBILITY OF THE DAMAGES ON THE MAINS SUPPLY CONTACTOR OF THE AUTOMATIC GENERATING SETS DUE TO OVERCURRENT, LOW, OR HIGH VOLTAGE.

NEVER REMOVE THE BATTERY TERMINALS WHILE THE GENERATING SET IS IN USE. EVEN A MOMENT OF DISCONNECTION CAN CAUSE DAMAGE ON THE ELECTRONIC CLOSING RELAY OF THE CHARGE ALTERNATOR AND ON THE ELECTRONIC ENGINE SPEED CONTROL CIRCUIT THESE CONDITIONS ARE NOT COVERED BY THE WARRANTY.

FAILURES DUE TO OVERLOAD AND UNBALANCED LOAD IN EXCESS OF THE GENERATING SET POWER (SUCH AS ALTERNATOR AND CONTACTOR FAILURES) ARE NOT COVERED BY THE WARRANTY.

FAILURES DUE TO OVERLOAD AND UNBALANCED LOAD IN EXCESS OF THE GENERATING SET POWER (SUCH AS ALTERNATOR AND CONTACTOR FAILURES) ARE NOT COVERED BY THE WARRANTY.

WHEN THE MANUAL GENERATING SET IS STARTED UP, IT SHOULD BE WARMED BY OPERATING AT IDLE FOR 5 MINUTES. WHEN STOPPING THE DIESEL ENGINE, IT SHOULD BE UNLOADED AND THEN CONTINUED TO BE OPERATED FOR COOLING FOR 10 MINUTES BEFORE STOPPING.

The below drawings are for reference only, subject to the drawings shipped with the generator set.

19. ELECTRICAL WRING DIAGRAMS

APD-ULJ30 - 40 - 55 - 65

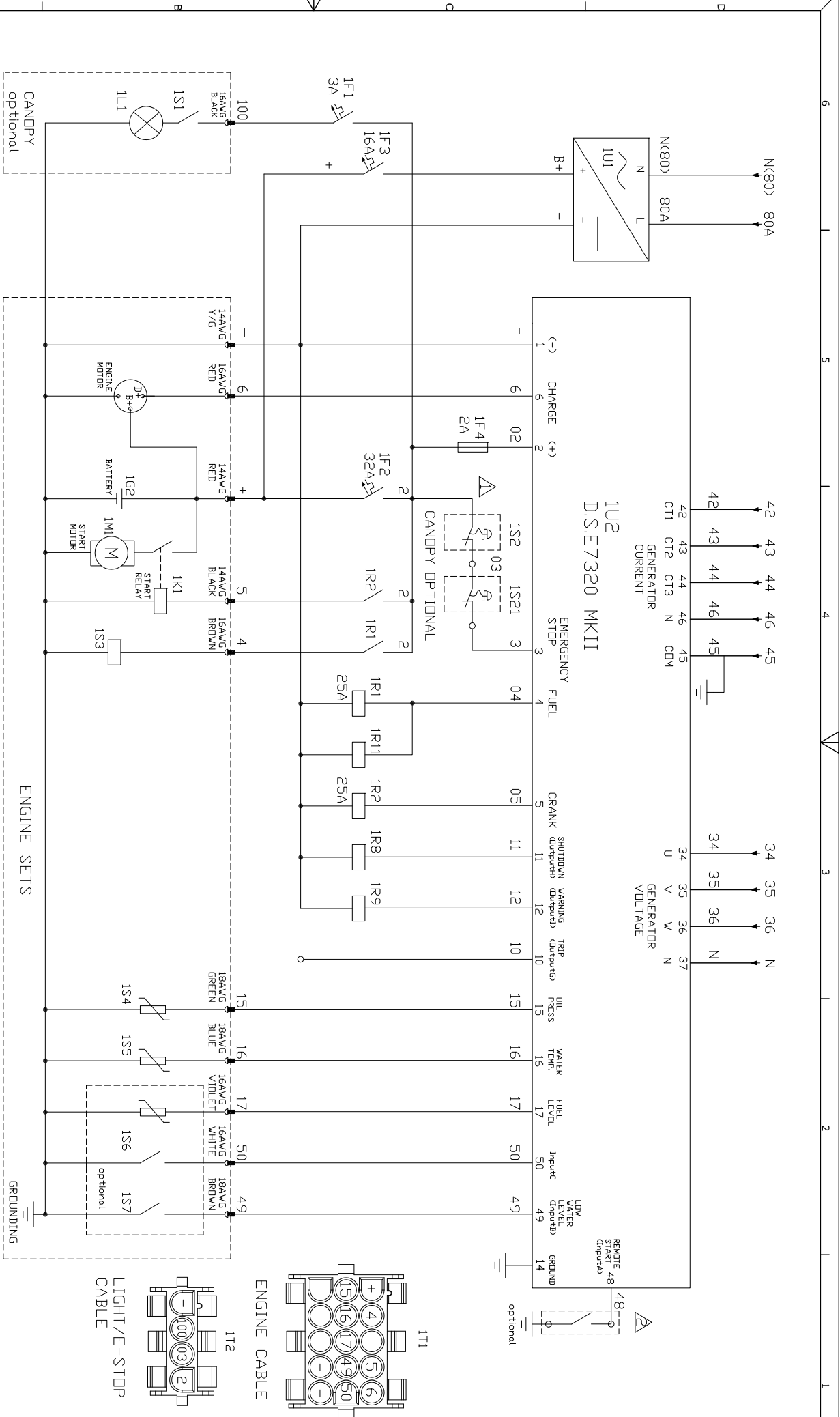

COPYRIGHT RESERVED
The design and detail of this drawing is the property of
Also Power Generation (China) Co., Ltd.
AND MUST BE RETURNED ON DEMAND. IT IS ISSUED ON THE STRICT
CONDITION OF NOT BEING REPRODUCED OR TRANSMITTED IN ANY
FORM OR BY ANY MEANS, ELECTRONIC OR MECHANICAL, INCLUDING
PHOTOGRAPHING, RECORDING, OR BY ANY INFORMATION STORAGE
RETRIEVAL SYSTEM, WITHOUT PERMISSION IN WRITING FROM
THIS COMPANY. ANY UNAUTHORIZED USE OF THIS DRAWING OR
CONTACT WITH OTHER THAN THAT STATED IN THE PARTICULAR ENQUIRY ORDER OR
DOCUMENT EXTENDS FROM EACH DATE APPEARING THERE ON AND IN RESPECT
OF THE SUBJECT MATTER AS IT APPEARED AT THE RELEVANT DATE.

ORDER CODE:		SCALE:	1:1	MATERIAL:		QUANTITY:		WEIGHT:	

ONLY ENGINEERING DEPT. OR ASST. COMP. HAS RIGHT TO REVISION
IF IT CAN NOT BE SUPPLIED OR GAINED TO THE RELEVANT DATE.

AUTOMATIK TRANSFER PANDSU AUTOMATIC TRANSFER SWITCH

WATER HEAT
MAINS VOLTAGE
AC120V

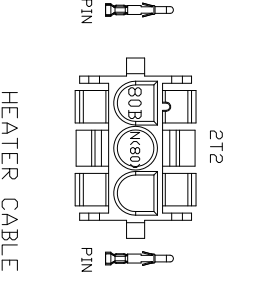
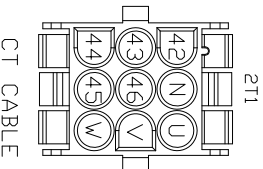
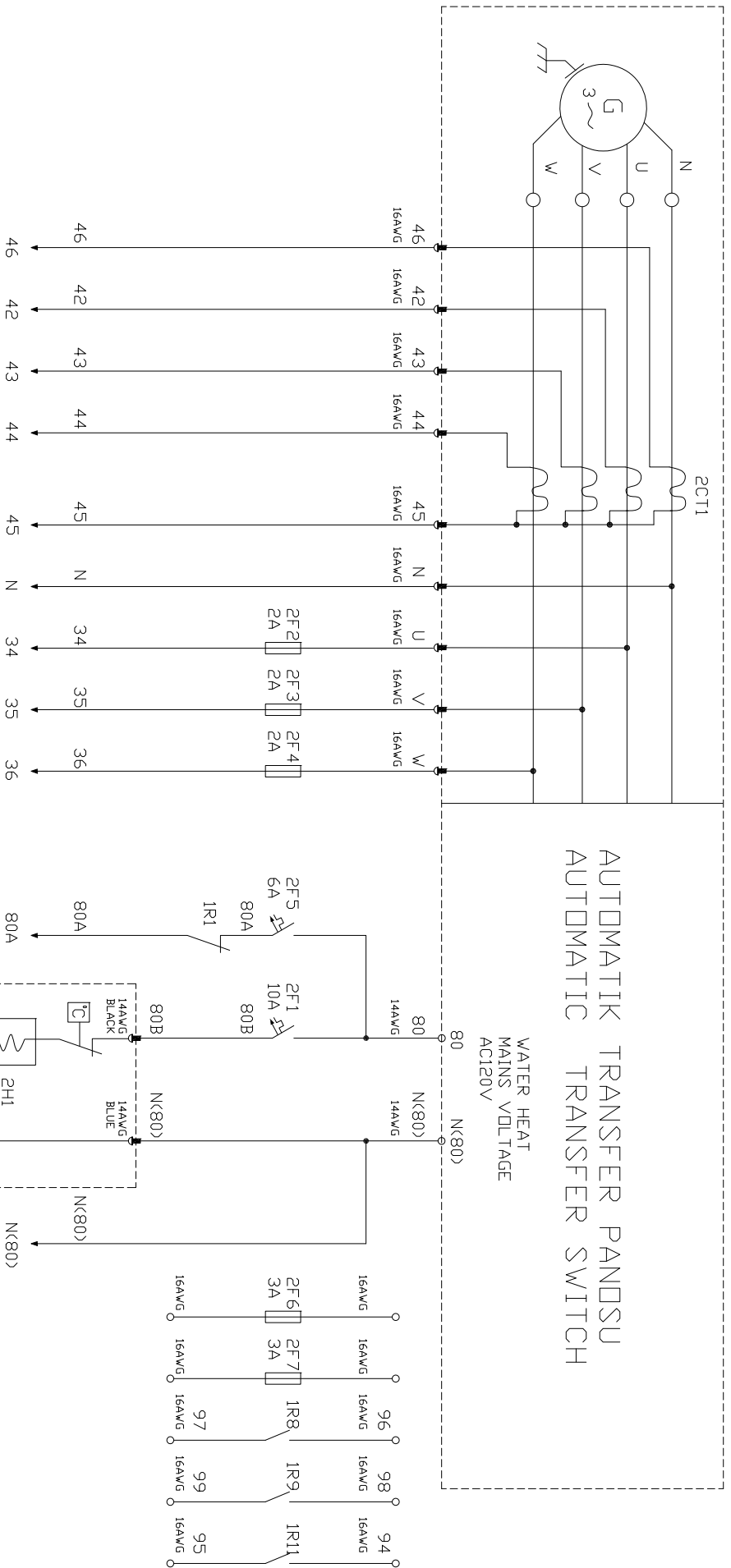

COPYRIGHT RESERVED

THE DESIGN AND DETAIL OF THIS DRAWING IS THE PROPERTY OF
Asaka Power Generation (CHINA) CO. LTD.
AND MUST BE KEPT IN CONFIDENTIALITY. IT IS NOT TO BE REPRODUCED,
COPIED OR COMMUNICATED TO ANY THIRD PARTY NOR BE USED FOR ANY
PURPOSE OTHER THAN THAT STATED IN THE PARTICULAR ENQUIRY, ORDER OR
CONTRACT WITH WHICH IT IS ISSUED. THE RESERVATION OF COPYRIGHT IN THIS
DOCUMENT EXTENDS FROM EACH DATE APPEARING THERE ON AND IN RESPECT
OF THE SUBJECT MATTER AS IT APPEARED AT THE RELEVANT DATE.

ORDER CODE:		SCALE: 1:1		MATERIAL:		QUANTITY:		WEIGHT:	
SIGN VARIATION		DATE		NAME		PART NAME:		START PANEL	
D	Change water heater power	2018.01.08	HELEN	USED FOR: ARP-UJ30/40/55/65 (JOHN DEERE 3029/4045TF/4045HF280 DSE7320MKII)		PART NO.:		DRAWING NO.: SP-12362080UL	
B	Change water heater circuit	2017.02.06	HELEN	DEPARTMENT: ENGINEERING		LOCATION:		PAGE A4	
A	Change DSE7320MKII	2016.06.14	CAOKUN	APPROVED BY: 01.08 SAMER		REVISION NO.: 04		PAGE 2-3	

A

6

5

4

3

2

1

B

6

5

4

3

2

1

C

6

5

4

3

2

1

D

6

5

4

3

2

1

COPYRIGHT RESERVED
 THE DESIGN AND DETAIL OF THIS DRAWING IS THE PROPERTY OF AND MUST BE RETURNED ON DEMAND. IT IS ISSUED ON THE STRICT CONDITION THAT WITHOUT WRITTEN PERMISSION IT MUST NOT BE REPRODUCED, COPIED OR COMMUNICATED TO ANY THIRD PARTY NOR BE USED FOR ANY PURPOSE OTHER THAN THAT STATED IN THE PARTICULAR ENQUIRY ORDER OR CONTRACT WITH WHICH IT IS ISSUED. THE RESERVATION OF COPYRIGHT IN THIS DRAWING IS NOT WAIVED BY THE INCLUSION OF THE FOLLOWING SUBJECT OF THE SUBJECT MATTER AS IT APPEARED AT THE RELEVANT DATE.

25	ZH1	WATER HEATER UL	
24	ZCT1	CURRENT TRANSFORMER UL	UL 1977
23	ZT2	TYCD 3HOLE 1-480701-0	UL 1977
22	ZT1	TYCD 9HOLE 1-480707-0	UL 1977
21	IT2	TYCD 4HOLE 1-480703-0	UL 1977
20	IT1	TYCD 15HOLE 1-480711-0	UL 1977
19	ZF4,ZF2,ZF3,ZF4	216002P/F2,0A 250V 5X20(FUSE)	UL 248
18	ZF5	ABB S20U K6A-IP4HIGH BREAKER MINI CURRENT CIRCUIT	UL 489
17	ZF1	ABB S20U K10A-IP4HIGH BREAKER MINI CURRENT CIRCUIT	UL 489
16	ZF3	ABB S20U K16A-IP4HIGH BREAKER MINI CURRENT CIRCUIT	UL 489
15	ZF2	ABB S20U K32A-IP4HIGH BREAKER MINI CURRENT CIRCUIT	UL 489
14	ZF1	ABB S20U K3A-IP4HIGH BREAKER MINI CURRENT CIRCUIT	UL 489
13	ZF6,ZF7	216315P/F315A 250V 5X20(FUSE)	UL 248
12	IU2	DEESEA7320 MKII MODULE	UL 508
11	IU1	BATTERY CHARGE AC230V/DC12V	UL 1236
10	IU1	CANDPY LIGHT PD771WRR DC12V	UL 1236
09	IS7	LOW WATER LEVEL SWITCH	
08	IS6	FEXIBLE SENSOR	
07	IS5	WATER TEMPERATURE SENSOR	
06	IS4	OIL PRESSURE SENSOR	
05	IS3	FUEL SOLENOID	
04	IS2	EMERGENCY STOP ABB UL	UL 94
03	IS1	CANDPY LIGHT SWITCH	
02	IR1,IR2	ROCKWELL 700-HHF6212/SCHLEIFER 389FXBXCI-12D DC12V 25A	UL 508
01	IR8,IR9,IR11	DRM270012LTRELAYAND RELAY NC CONTACTOR	UL 508
ITEM	PART NO.	ITEM DESCRIPTION	UL REQUIREMENT

	PE(16AWG Y/G)	0	01	PE	0	0	PE	
	PE(16AWG Y/G)	0	02	PE	0	0	PE	
	PE(16AWG Y/G)	0	03	PE	0	0	PE	
	48(16AWG BLACK)	0	04	48	0	0	48	
	2(16AWG BLACK)	0	05	2	0	0	2	REMOTE START/STOP
	2(16AWG BLACK)	0	06	2	0	0	2	
	03(16AWG BLACK)	0	07	03	0	0	03	
	3(16AWG BLACK)	0	08	3	0	0	3	
	80(14AWG BLACK)	0	09	80	0	0	80	WATER HEATER AND BATTERY CHARGER
	N(80)(14AWG BLUE)	0	010	N(80)	0	0	N(80)	
	N(80)(14AWG BLUE)	0	011	N(80)	0	0	N(80)	
	81(14AWG BLACK)	0	012	81	0	0	81	ALT STRIP HEATER
	N(81)(14AWG BLUE)	0	013	N(81)	0	0	N(81)	
	82(14AWG BLACK)	0	014	82	0	0	82	AC LIGHT
	N(82)(14AWG BLUE)	0	015	N(82)	0	0	N(82)	
	83(14AWG BLACK)	0	016	83	0	0	83	BATTERY HEATER
	N(83)(14AWG BLUE)	0	017	N(83)	0	0	N(83)	
	84(14AWG BLACK)	0	018	84	0	0	84	OIL HEATER
	N(84)(14AWG BLUE)	0	019	N(84)	0	0	N(84)	
	85(14AWG BLACK)	0	020	85	0	0	85	RECEPTACLE
	N(85)(14AWG BLUE)	0	021	N(85)	0	0	N(85)	
	86(14AWG BLACK)	0	022	86	0	0	86	
	10(16AWG BLACK)	0	023	10	0	0	10	
	94(16AWG BLACK)	0	024	94	0	0	94	RUNNING
	95(16AWG BLACK)	0	025	95	0	0	95	
	96(16AWG BLACK)	0	026	96	0	0	96	SHUTDOWN
	97(16AWG BLACK)	0	027	97	0	0	97	
	98(16AWG BLACK)	0	028	98	0	0	98	
	99(16AWG BLACK)	0	029	99	0	0	99	WARNING

△ Canopy Gen-set do not install emergency stop IS2 button in start panel. IS21 is optional emergency stop.
 △ Ifor all Aksa USA UL gensets are using two wire start off of digital input 48 to start the genset up.
 △ :1~6#Terminal model:Weldmuller ZDU 2.5/4AN UL(UL1059). 7~29#Terminal model:Weldmuller ZDU2.5 UL(UL1059).

ORDER CODE: 1:1 SCALE: 1:1
 DEPARTMENT: ENGINEERING

 DEPARTMENT: ENGINEERING
 USED FOR: APP-U130/40/55/65 (JOHN DEERE 3029/4045TF/4045HF280 DSE7320MK1I)
 PART NO.: SP12362080UL
 DRAWING NO.: SP12362080UL
 REVISION NO.: 04
 SIGN VARIATION: 3
 DATE: 2018.04.14
 NAME: CACKUN
 DATE: 2018.01.08
 NAME: HELEN
 DATE: 2017.02.06
 NAME: HANG
 DATE: 2016.04.14
 NAME: CACKUN

MATERIAL:	QUANTITY:	WEIGHT:
PART NAME: START PANEL		

A4	PAGE
3-3	PAGE
PRINTED ON RECYCLED PAPER. ALL RIGHTS RESERVED. ANY REPRODUCTION OR MODIFICATION WITHOUT THE WRITTEN PERMISSION OF THE ORGANIZATION IS STRICTLY PROHIBITED.	

APD-ULJ80 - 125

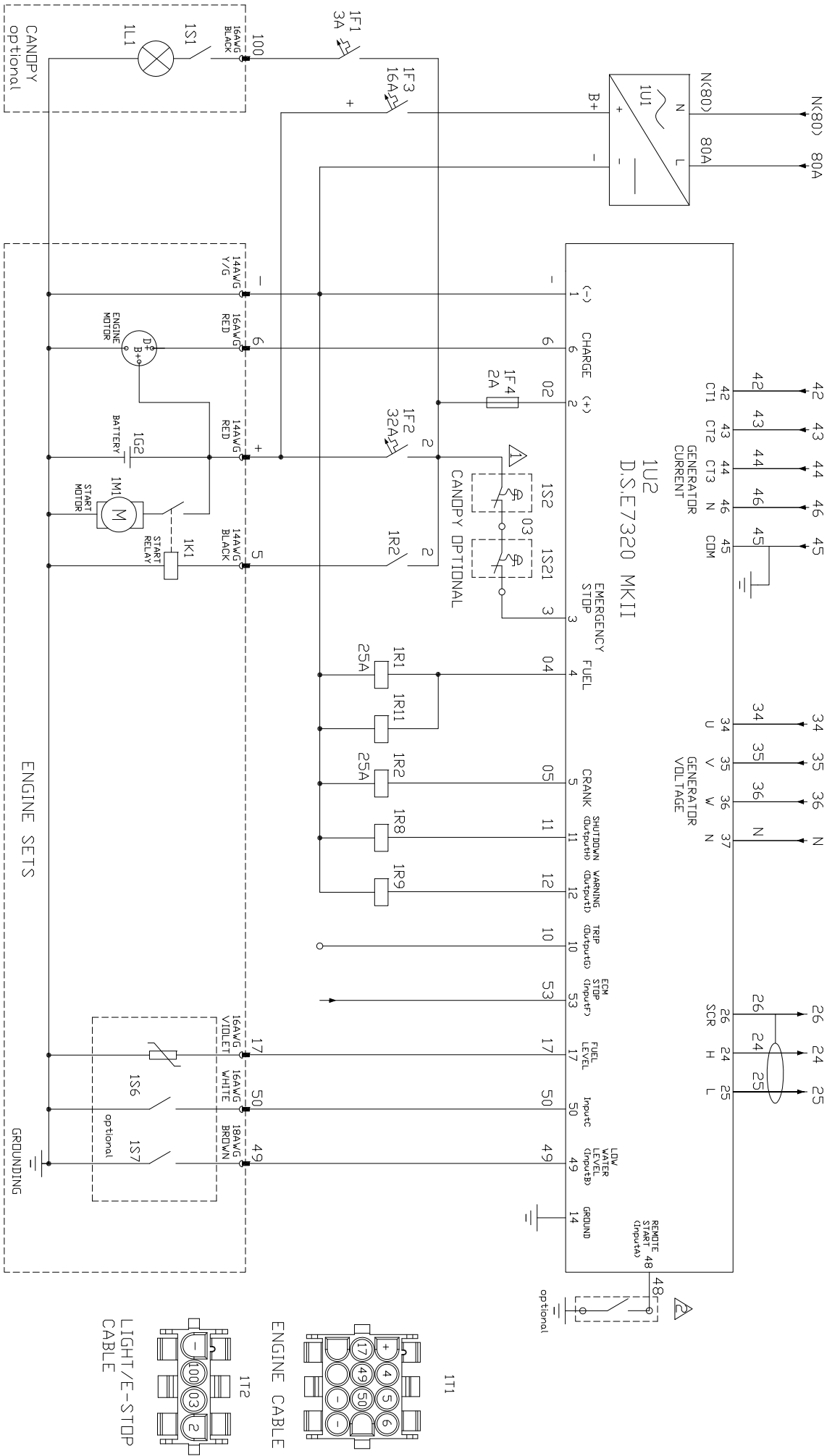

1U2
D.S.E7320 MKII

ENGINE SETS

GROUNDING

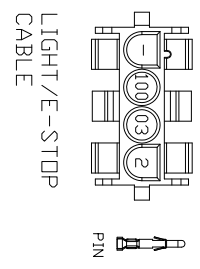
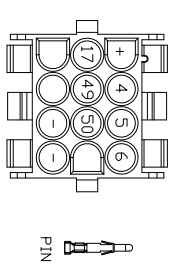

COPYRIGHT RESERVED ©
 THE DESIGN AND DETAIL OF THIS DRAWING IS THE PROPERTY OF
 Also Power Generation (China) Co., Ltd.
 AND MUST BE RETURNED ON DEMAND. IT IS ISSUED ON THE STRICT
 CONFIDENTIALITY BASIS. ANY REPRODUCTION, COPIED, OR COMMUNICATED TO ANY THIRD PARTY, NOR BE USED FOR ANY
 PURPOSE OTHER THAN THAT STATED IN THE PARTICULAR ENQUIRY ORDER OR
 CONTRACT WITH WHICH IT IS ISSUED IN THE RESERVATION OF COPYRIGHT IN THIS
 DOCUMENT EXTENDS FROM EACH DATE APPEARING THERE ON AND IN RESPECT
 OF THE SUBJECT MATTER AS IT APPEARED AT THE RELEVANT DATE.

ORDER CODE:	SCALE: 1:1	MATERIAL:	QUANTITY:	WEIGHT:

DEPARTMENT: ENGINEERING	DATE: 2018.01.24	SIGNATURE: HELEN	DATE: 2016.04.14	NAME: CAOKUN
DESIGNED BY: 01.24 TOM	APPROVED BY: 01.24 SAMER			
PART NO.: APP-UD80/100/125(OAHN DEERE 4045HF DSE7320MKII)	DRAWING NO.: SP-12362081UL	LOCATION: A4	PAGE: 1-4	
REVISION NO.: 04				

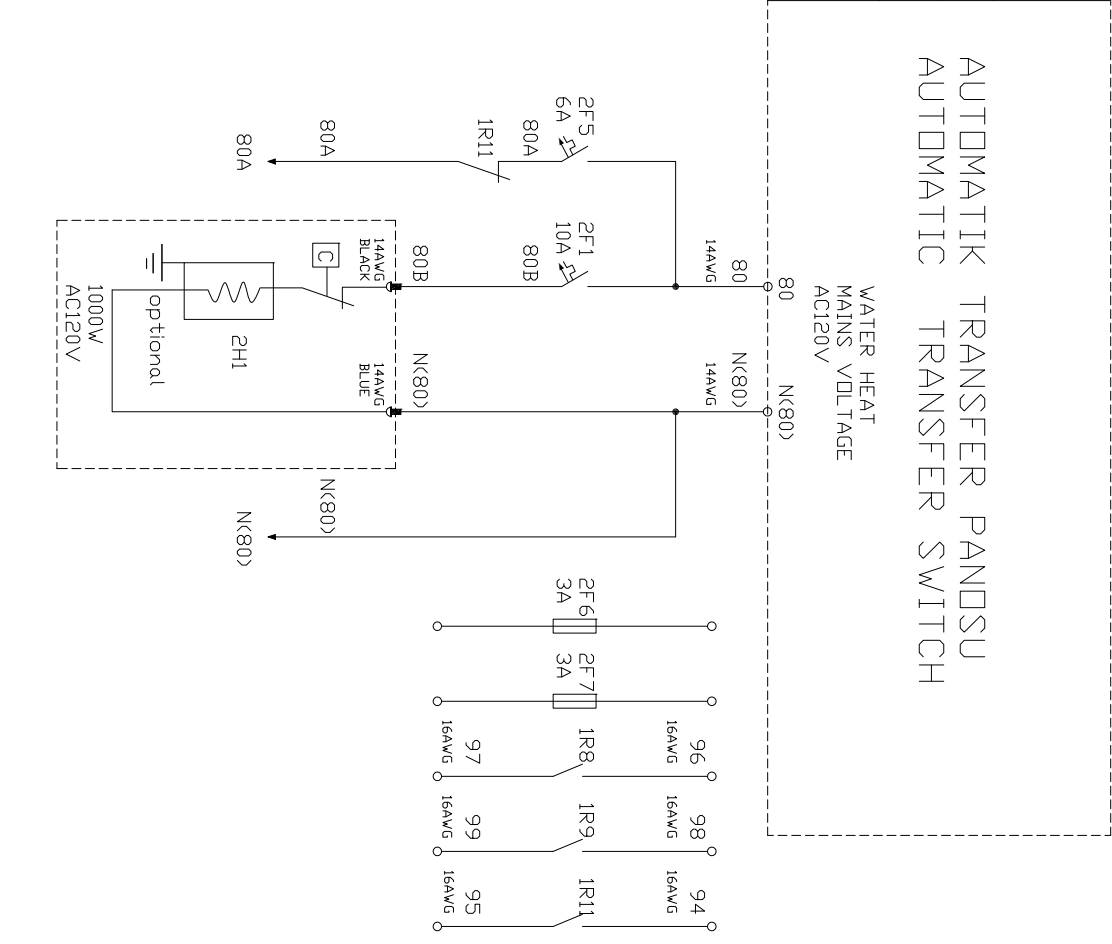
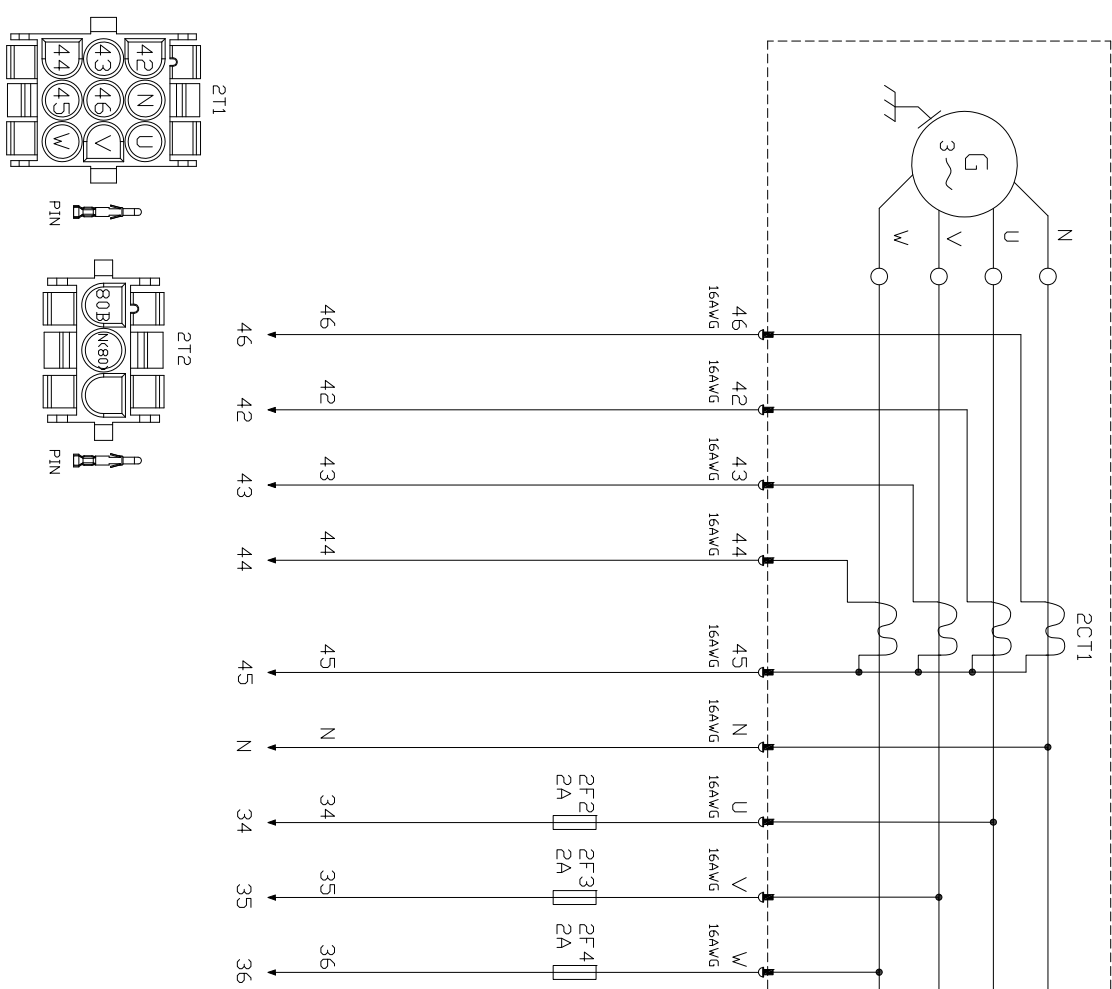

CT CABLE

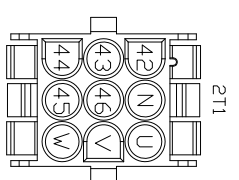

HEATER CABLE

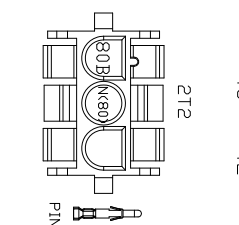

COPYRIGHT RESERVED

THE DESIGN AND DETAIL OF THIS DRAWING IS THE PROPERTY OF Aska Power Generation (China) Co., Ltd. AND MUST BE KEPT CONFIDENTIAL. IT IS NOT TO BE REPRODUCED, COPIED OR COMMUNICATED TO ANY THIRD PARTY NOR BE USED FOR ANY PURPOSE OTHER THAN THAT STATED IN THE PARTICULAR ENQUIRY ORDER OR CONTRACT WITH WHICH IT IS ISSUED. THE RESERVATION OF COPYRIGHT IN THIS DOCUMENT EXTENDS FROM EACH DATE APPEARING THERE ON AND IN RESPECT OF THE SUBJECT MATTER AS IT APPEARED AT THE RELEVANT DATE.

ORDER CODE:	SCALE: 1:1	MATERIAL:	QUANTITY:	WEIGHT:
	2018	DATE NAME	SIGNATURE	
	2018.01.24	HELEN		
	2017.02.06	HELEN		
	2016.04.14	CAOKUN		
DEPARTMENT: ENGINEERING				
PART NAME: START PANEL				
USED FOR: APD-UI80/100/125(O)HN DEERE 4045HF DSE7320MK11)				
DRAWING NO.: SP-12362081UL				
REVISION NO.: 04				
PART NO.:			LOCATION:	
A4				
PAGE			2-4	

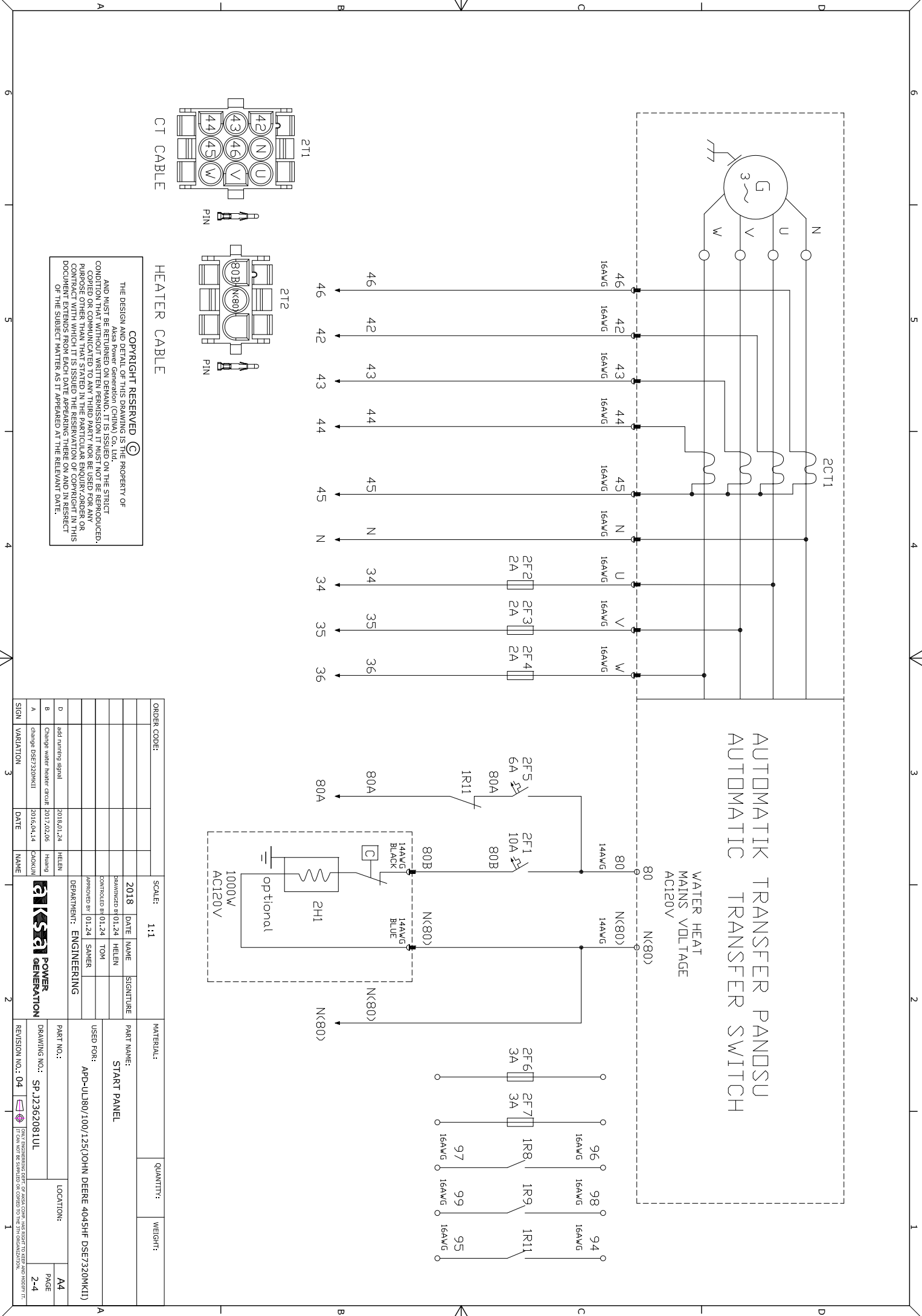

JOHN DEERE ECU(ENGINE CONTROL MODULE)

3U1

DIESEL ENGINE

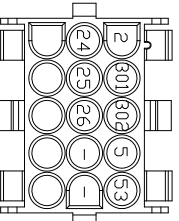
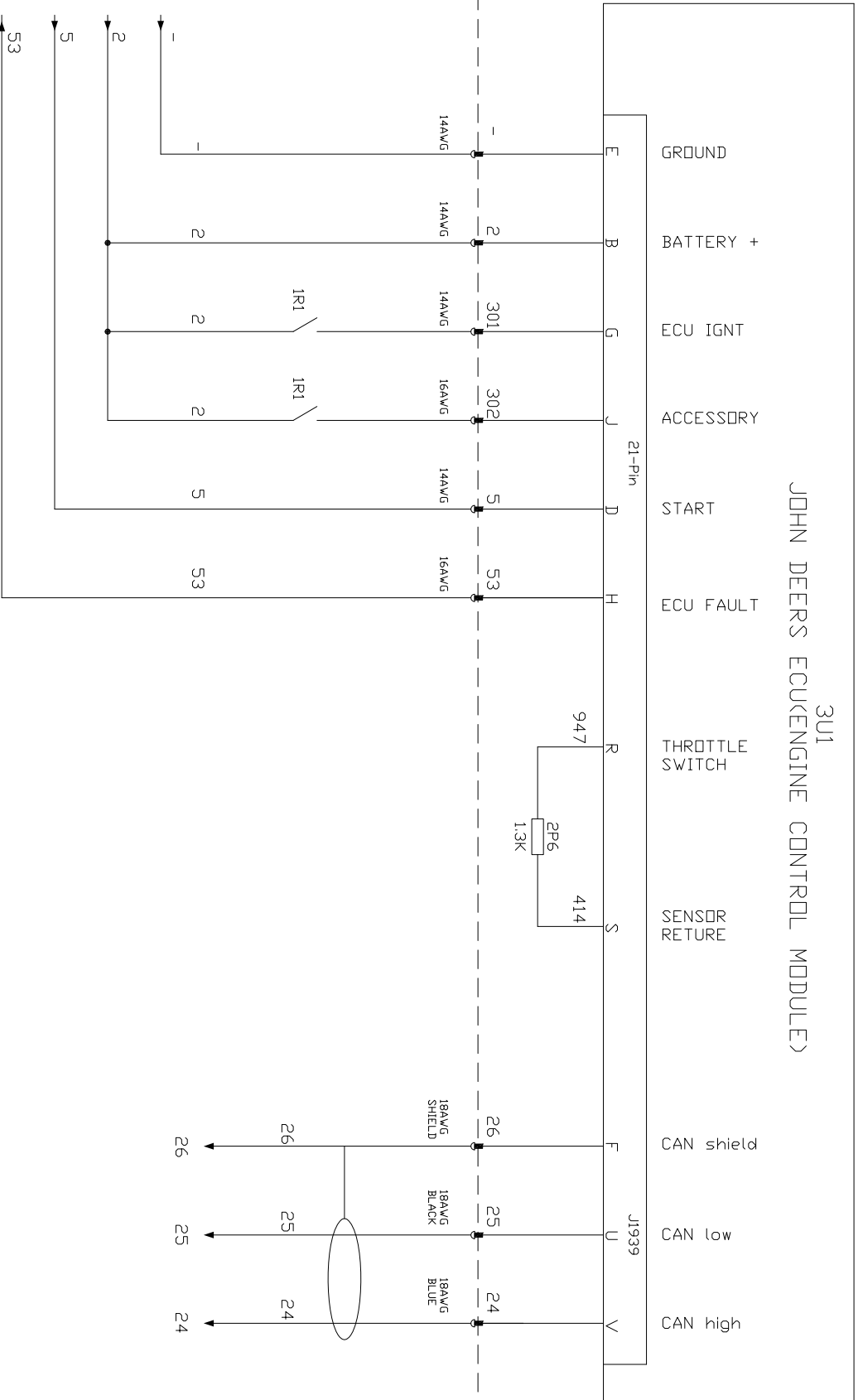

311

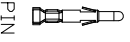

PIN

ENGINE ECM CABLE

COPYRIGHT RESERVED ©

THE DESIGN AND DETAIL OF THIS DRAWING IS THE PROPERTY OF
 Aisa Power Generation (CHINA) CO., LTD.
 AND MUST BE KEPT IN CONFIDENCE. IT IS NOT TO BE REPRODUCED,
 COPIED OR COMMUNICATED TO ANY THIRD PARTY NOR BE USED FOR ANY
 PURPOSE OTHER THAN THAT STATED IN THE PARTICULAR ENQUIRY, ORDER OR
 CONTRACT WITH WHICH IT IS ISSUED. THE RESERVATION OF COPYRIGHT IN THIS
 DOCUMENT EXTENDS FROM EACH DATE APPEARING THERE ON AND IN RESPECT
 OF THE SUBJECT MATTER AS IT APPEARED AT THE RELEVANT DATE.

ORDER CODE:		SCALE: 1:1		MATERIAL:		QUANTITY:		WEIGHT:	
		2018		DRAWING NO: 01.24		DATE: 01.24		SIGNATURE: HELEN	
		B		Change water heater circuit		2017.02.06		HELEN	
		A		change DSE7320MKII		2016.04.14		CAOKUN	
SIGN VARIATION:		DATE		NAME					
				DEPARTMENT: ENGINEERING					
PART NO.:		PART NAME:		USED FOR:					
APD-UJ80/100/125(JOHN DEERE 4045HF DSE7320MKII)		START PANEL		DRAWING NO.: SP J2362081U1					
REVISION NO.: 04		LOCATION:		PAGE					
				A4					
				3-4					

ONLY ENGINEERING DEPT. OF AISA CO., LTD. HAS RIGHT TO KEEP AND MODIFY IT. IT CAN NOT BE SPANDED OR COPIED TO THE 3TH ORGANIZATION.

COPYRIGHT RESERVED

THE DESIGN AND DETAIL OF THIS DRAWING IS THE PROPERTY OF
AND MUST BE RETURNED ON DEMAND. IT IS ISSUED ON THE STRICT
CONDITION THAT WITHOUT WRITTEN PERMISSION IT MUST NOT BE REPRODUCED,
COPIED OR COMMUNICATED TO ANY THIRD PARTY NOR BE USED FOR ANY
PURPOSE OTHER THAN THAT STATED IN THE PARTICULAR ENQUIRY ORDER OR
CONTRACT WITH WHICH IT IS ISSUED. THE RESERVATION OF COPYRIGHT IN THIS
DRAWING AND THE SUBJECT MATTER AS IT APPEARED AT THE RELEVANT DATE.

ITEM	PART NO.	ITEM DESCRIPTION	UL REQUIREMENT
24	2H1	WATER HEATER UL	
23	2C11	CURRENT TRANSFORMER UL	UL 508
22	311	TYCO 15HOLE 1-480711-0	UL 1977
21	212	TYCO 3HOLE 1-480701-0	UL 1977
20	211	TYCO 9HOLE 1-480707-0	UL 1977
19	1T2	TYCO 4HOLE 1-480703-0	UL 1977
18	1T1	TYCO 12HOLE 1-480709-0	UL 1977
17	1F4,2F2,2F3,2F4	216002P/F2.0A 250V 5x20(FUSED)	UL 248
16	2F5	ABB S20U K6A-1P(HIGH BREAKER MINI CURRENT CIRCUIT)	UL 489
15	2F1	ABB S20U K10A-1P(HIGH BREAKER MINI CURRENT CIRCUIT)	UL 489
14	1F3	ABB S20U K16A-1P(HIGH BREAKER MINI CURRENT CIRCUIT)	UL 489
13	1F2	ABB S20U K32A-1P(HIGH BREAKER MINI CURRENT CIRCUIT)	UL 489
12	1F1	ABB S20U K3A-1P(HIGH BREAKER MINI CURRENT CIRCUIT)	UL 489
11	2F6,2F7	216315P/F315A 250V 5x20(FUSED)	UL 248
10	1U2	DEESEA7320 MKII MODULE	UL 508
09	1U1	BATTERY CHARGE ACC230V/DC12V	UL 1236
08	1L1	CANOPY LIGHT PD771WRR DC12V	
07	1S7	L0W WATER LEVEL SWITCH	
06	1S6	FLEXIBLE SENSOR	
05	1S3	FUEL SOLENOID	
04	1S2	EMERGENCY STOP ABB UL	UL 94
03	1S1	CANOPY LIGHT SWITCH	
02	1R1,1R2	ROCKWELL 700-HHF6212/SCHEDER 389FXBXCI-12D DC12V 25A	UL 508
01	1R11,1R8,1R9	DRM270012LTKRELAAYAND RELAY NC CONTACTOR	UL 508

ITEM	PART NO.	ITEM DESCRIPTION	UL REQUIREMENT
01	PE(16AWG Y/G)	PE	
02	PE(16AWG Y/G)	PE	
03	PE(16AWG Y/G)	PE	
04	48(16AWG BLACK)	48	
05	2(16AWG BLACK)	2	
06	2(16AWG BLACK)	2	
07	03(16AWG BLACK)	03	
08	3(16AWG BLACK)	3	
09	80(14AWG BLACK)	80	
10	N(80)(14AWG BLUE)	N(80)	
11	N(80)(14AWG BLUE)	N(80)	
12	81(14AWG BLACK)	81	
13	N(81)(14AWG BLUE)	N(81)	
14	82(14AWG BLACK)	82	
15	N(82)(14AWG BLUE)	N(82)	
16	83(14AWG BLACK)	83	
17	N(83)(14AWG BLUE)	N(83)	
18	84(14AWG BLACK)	84	
19	N(84)(14AWG BLUE)	N(84)	
20	85(14AWG BLACK)	85	
21	N(85)(14AWG BLUE)	N(85)	
22	86(14AWG BLACK)	86	
23	10(16AWG BLACK)	10	
24	94(16AWG BLACK)	94	
25	95(16AWG BLACK)	95	
26	96(16AWG BLACK)	96	
27	97(16AWG BLACK)	97	
28	98(16AWG BLACK)	98	
29	99(16AWG BLACK)	99	

Canopy Gen-set do not install emergency stop I52 button in start panel. I521 is optional emergency stop.
 For all Aksa USA UL gensets are using two wire start off of digital input 48 to start the genset up.
 1~6# Terminal model: Weidmuller ZDU 2.5/4AN UL(UL1059). 7~29# Terminal model: Weidmuller ZDU 2.5 UL(UL1059).

ORDER CODE:		SCALE: 1:1		MATERIAL:		QUANTITY:		WEIGHT:	
PART NO.:		DATE NAME SIGNATURE		PART NAME:		START PANEL		USED FOR:	
DRAWING NO.:		APPROVED BY		DEPARTMENT:		PART NO.:		LOCATION:	
REVISION NO.:		DATE		ENGINEERING		DRAWING NO.:		PAGE	
04		2018.01.24		HELEN		APP-UD80/100/12500HN DEERE 4045HF DSE7320MK11		4-4	
SIGN VARIATION:		DATE		NAME		DRAWING NO.:		PAGE	
3		2018.01.24		HELEN		SP-12362081UL		4-4	
A		change DSE7320MK11		CACKUN		REVISION NO.:		PAGE	
4		2016.04.14		CACKUN		04		4-4	

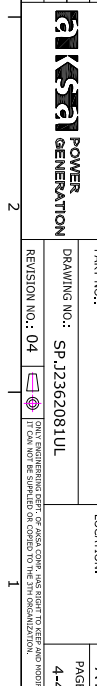

ONLY ENGINEERING DEPT. OF AKSA CORP. HAS RIGHT TO KEEP AND MODIFY THIS DRAWING. IT CAN NOT BE SHARED OR COPIED TO THE 3RD ORGANIZATION.

APD-ULJ150 – 275

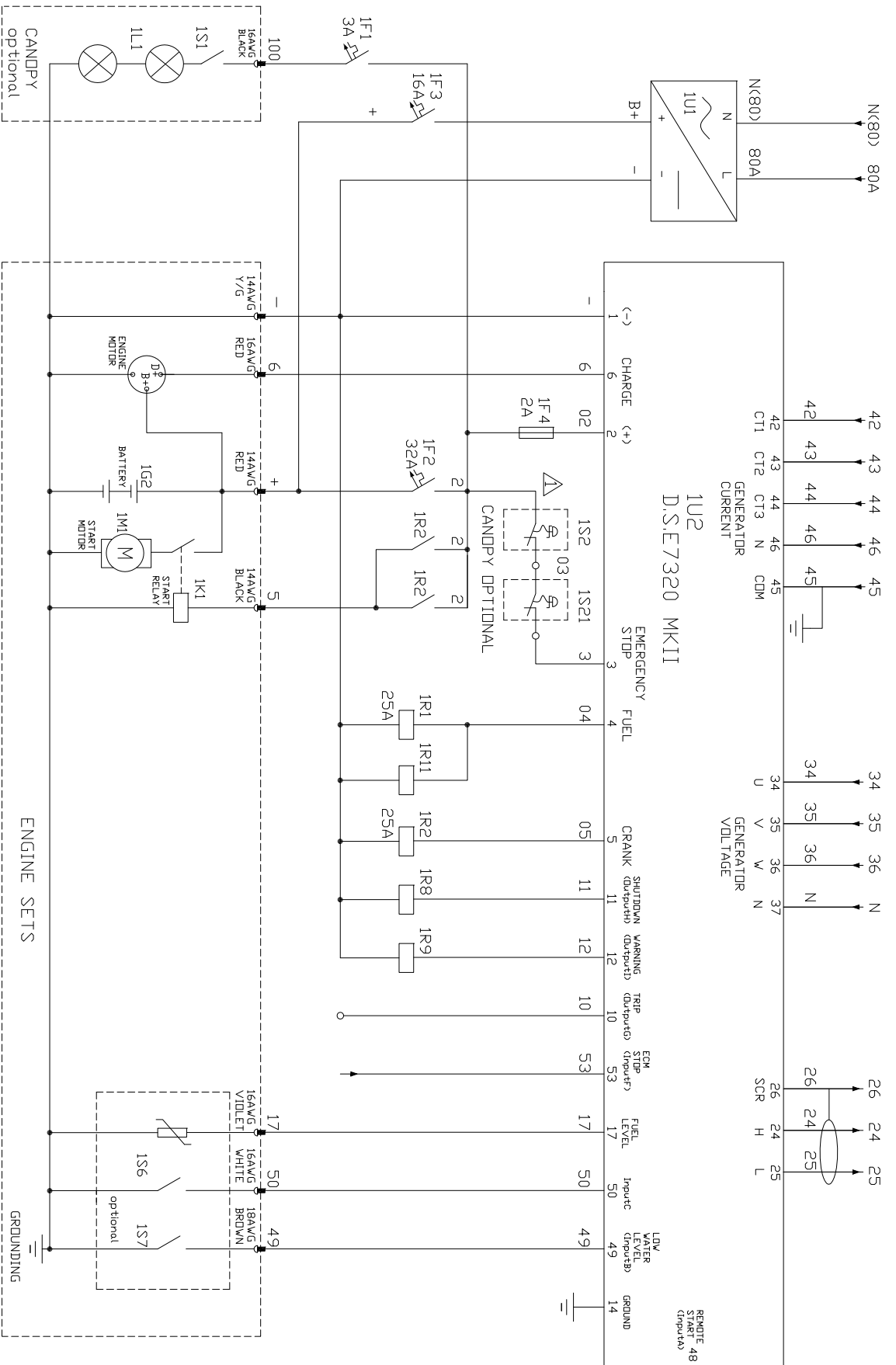

ENGINE SETS

GROUNDING

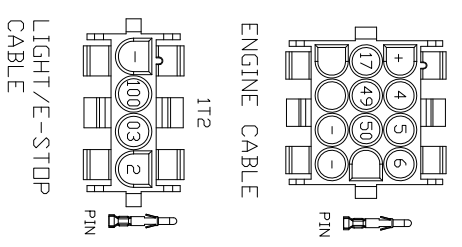

COPYRIGHT RESERVED
 THE DESIGN AND DETAIL OF THIS DRAWING IS THE PROPERTY OF
 Also Power Generation (CHINA) Co., Ltd.
 AND MUST BE RETURNED ON DEMAND. IT IS ISSUED ON THE STRICT
 CONFIDENTIALITY BASIS. ANY REPRODUCTION, COPIED OR COMMUNICATED TO ANY THIRD PARTY, NOT BE USED FOR ANY
 PURPOSE OTHER THAN THAT STATED IN THE PARTICULAR ENQUIRY ORDER OR
 CONTRACT WITH WHICH IT IS ISSUED. IN THE RESERVATION OF COPYRIGHT IN THIS
 DOCUMENT EXTENDS FROM EACH DATE APPEARING THERE ON AND IN RESPECT
 OF THE SUBJECT MATTER AS IT APPEARED AT THE RELEVANT DATE.

ORDER CODE:	SCALE: 1:1	MATERIAL:	QUANTITY:	WEIGHT:
	2018	DATE NAME	SIGNATURE	PART NAME:
		DRAWING BY 01.24 HELEN		START PANEL
		CONTROLLED BY 01.24 TOMI		
		APPROVED BY 01.24 SAMER		
DEPARTMENT: ENGINEERING		PART NO.: ARD-UJ250/275		
USED FOR: (JOHN DEERE 6090HF DCC24V DSE7320MK11)		DRAWING NO.: SP-12362082UL		
SIGN VARIATION		DATE	NAME	LOCATION:
D	add running signal	2018.01.24	HELEN	A4
B	Change water heater draft	2017.02.06	Huang	PAGE 1-4
A	change DSE7320MK11	2016.04.14	CAOKUN	
REVISION NO.: 04		ONLY ENGINEERING DEPT. OF ASIA CORP. HAS RIGHT TO KEEP AND MODIFY IT. IT CAN NOT BE PRINTED OR COPIED TO THE 3RD ORGANIZATION.		

AUTOMATIK TRANSFER PANDSU AUTOMATIC TRANSFER SWITCH

WATER HEAT
MAINS VOLTAGE
AC120V

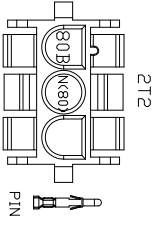
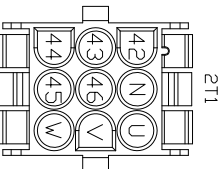
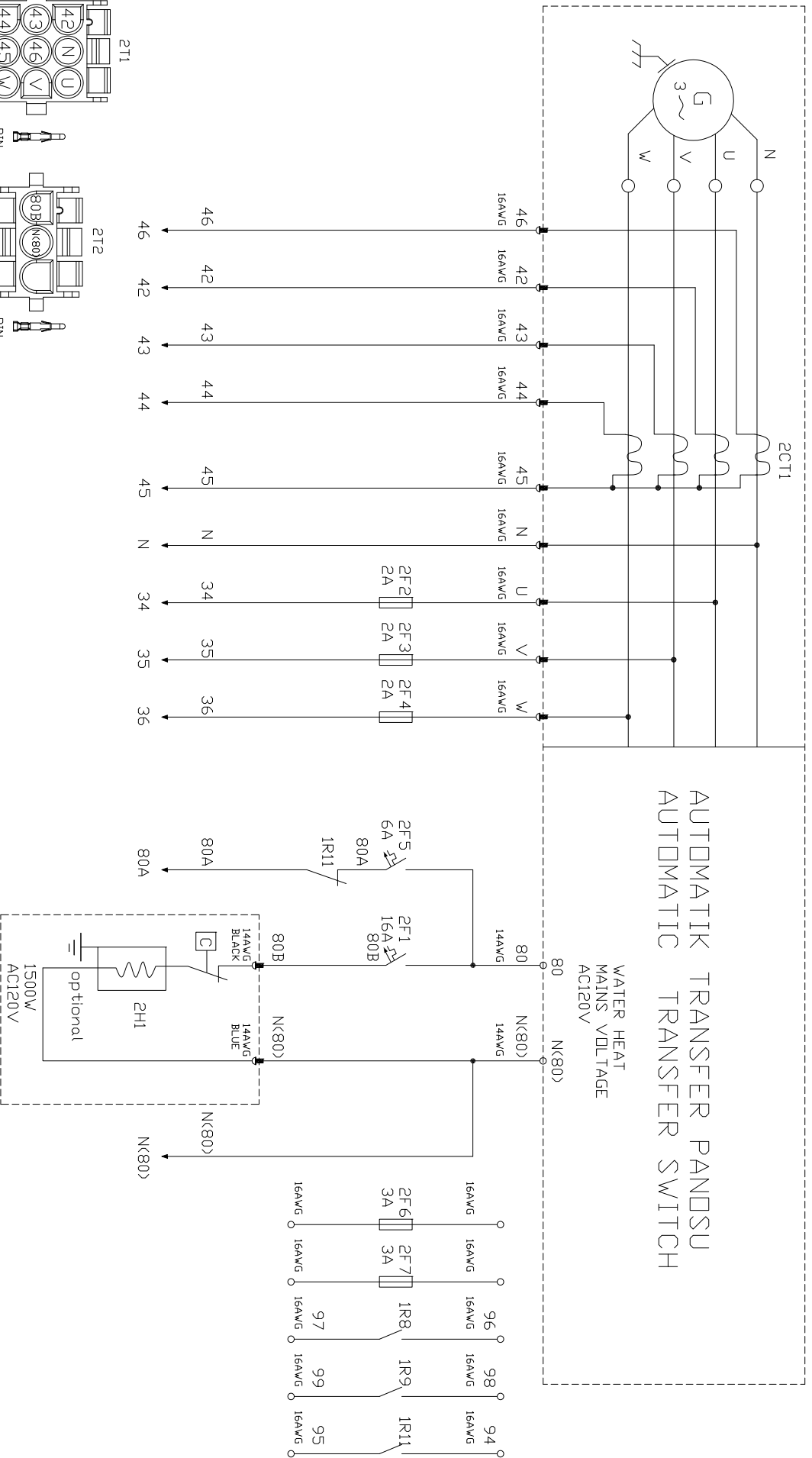

COPYRIGHT RESERVED
 THE DESIGN AND DETAIL OF THIS DRAWING IS THE PROPERTY OF
 Asaka Power Generation (CHINA) CO. LTD.
 AND MUST BE KEPT CONFIDENTIAL. IT IS NOT TO BE REPRODUCED,
 COPIED OR COMMUNICATED TO ANY THIRD PARTY NOR BE USED FOR ANY
 PURPOSE OTHER THAN THAT STATED IN THE PARTICULAR ENQUIRY, ORDER OR
 CONTRACT WITH WHICH IT IS ISSUED. THE RESERVATION OF COPYRIGHT IN THIS
 DOCUMENT EXTENDS FROM EACH DATE APPEARING THERE ON AND IN RESPECT
 OF THE SUBJECT MATTER AS IT APPEARED AT THE RELEVANT DATE.

ORDER CODE:	SCALE: 1:1	MATERIAL:	QUANTITY:	WEIGHT:
	2018	DATE NAME	SIGNATURE	
		DRAWN BY: 01.24 HELEN		
		CONTROLLED BY: 01.24 TOMI		
		APPROVED BY: 01.24 SAMBER		
	DEPARTMENT: ENGINEERING			
D	edit naming signal	2018.01.24	HELEN	
B	change water heater circuit	2017.02.06	HELEN	
A	change DSEF320MK11	2016.04.14	CAOKUN	
SIGN	VARIATION	3	DATE	NAME
PART NAME: START PANEL		PART NO.:	A4	
USED FOR: ARD-U1250/275 (JOHN DEERE 6090HF DC24V DSEF320MK11)		DRAWING NO.:	PAGE	
REVISION NO.: 04		SP J2362082UL	2-4	
LOCATION:		<small>THIS ENGINEERING DEPT. OF ASAKA CORP. HAS RIGHT TO KEEP AND MODIFY THE DRAWING. IT CAN NOT BE SPANNED OR COPIED TO THE 3RD ORGANIZATION.</small>		

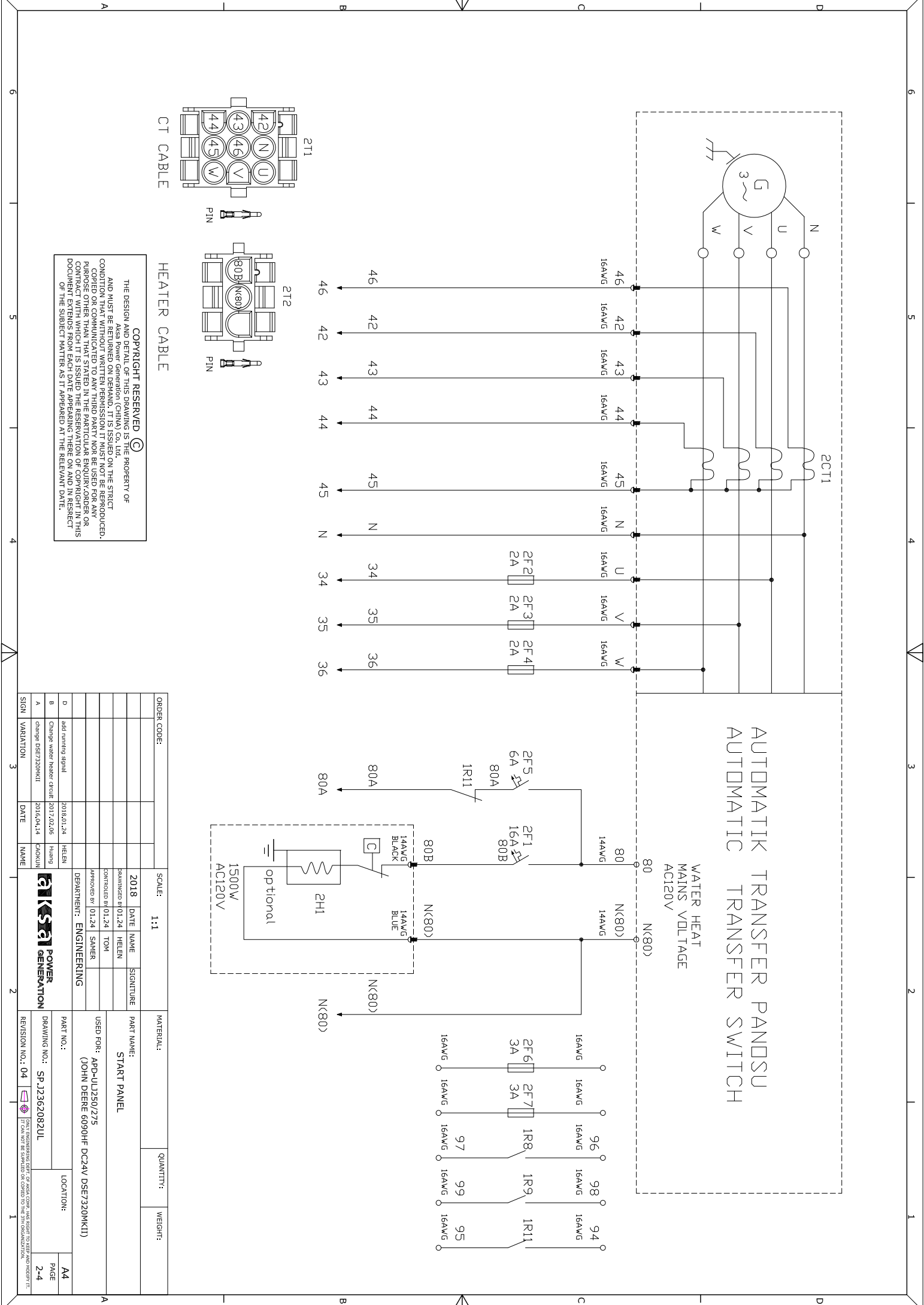

JOHN DEERE ECU(ENGINE CONTROL MODULE)

DIESEL ENGINE

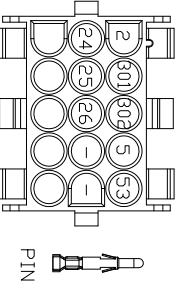
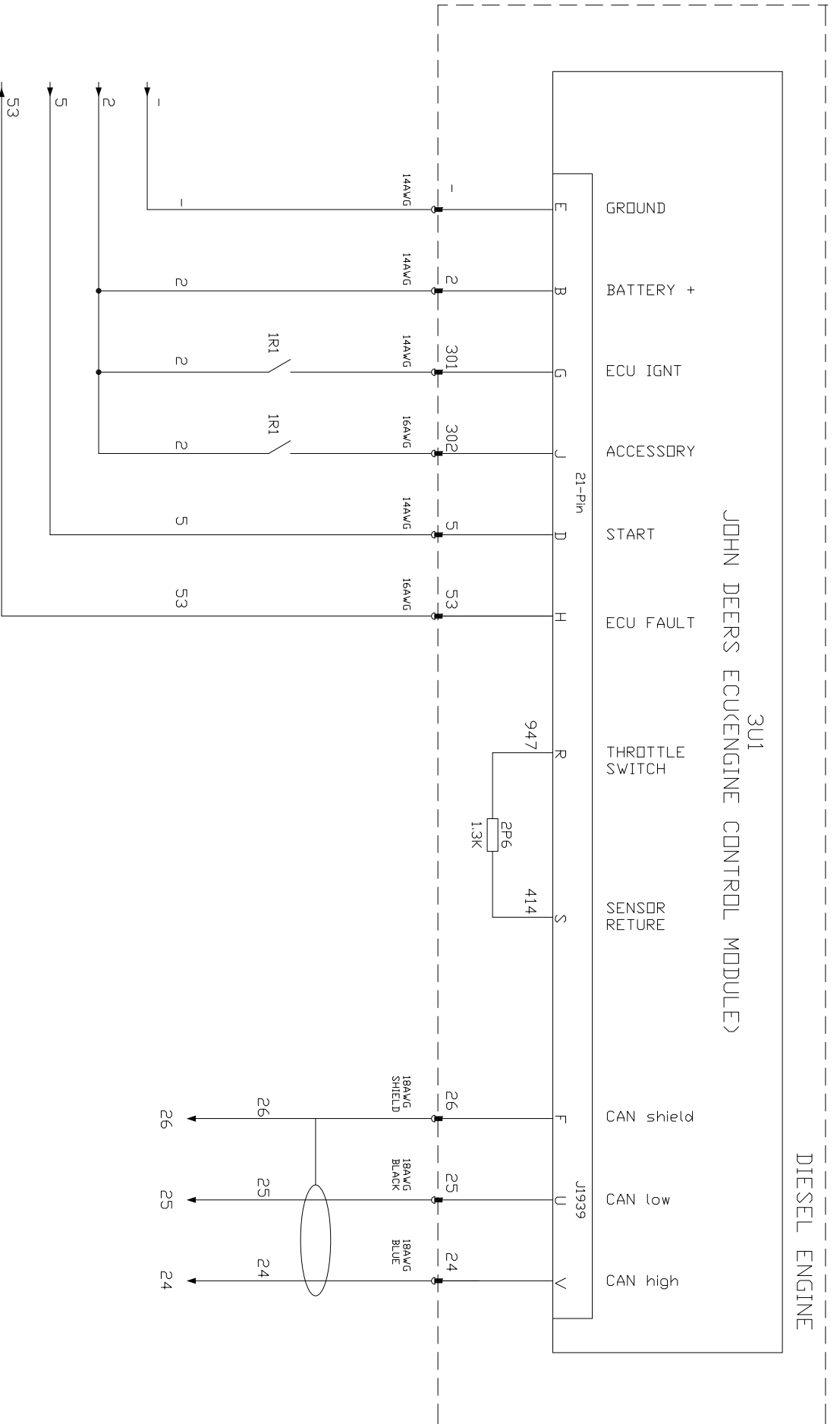

ENGINE ECM CABLE

COPYRIGHT RESERVED ©

THE DESIGN AND DETAIL OF THIS DRAWING IS THE PROPERTY OF
Aksa Power Generation (CHINA) CO., LTD.
AND MUST BE KEPT IN CONFIDENCE. IT IS TO BE USED ONLY FOR THE
CONDITION THAT WITHOUT WRITTEN PERMISSION IT MUST NOT BE REPRODUCED,
COPIED OR COMMUNICATED TO ANY THIRD PARTY NOR BE USED FOR ANY
PURPOSE OTHER THAN THAT STATED IN THE PARTICULAR ENQUIRY, ORDER OR
CONTRACT WITH WHICH IT IS ISSUED. THE RESERVATION OF COPYRIGHT IN THIS
DOCUMENT EXTENDS FROM EACH DATE APPEARING THERE ON AND IN RESPECT
OF THE SUBJECT MATTER AS IT APPEARED AT THE RELEVANT DATE.

ORDER CODE:		SCALE: 1:1		MATERIAL:		QUANTITY:		WEIGHT:	
		2018		DRAWING NO: 01.24		HELEN			
		B		Change water heater circuit		2017.02.06		HELEN	
		A		change DSEF320MK11		2016.04.14		CAO(KUN)	
SIGN VARIATION:		DATE		NAME		DEPARTMENT: ENGINEERING		PART NO.:	
								USED FOR: APD-UJ1250/275	
								(JOHN DEERE 6090HF DC24V DSEF320MK11)	
								DRAWING NO.: SP J2362082UL	
								REVISION NO.: 04	
								LOCATION:	
								PAGE	
								3-4	

ONLY ENGINEERING DEPT. OF AKSA CORP. HAS RIGHT TO KEEP AND MODIFY IT.
IT CAN NOT BE SPANNED OR COPIED TO THE 3RD ORGANIZATION.

COPYRIGHT RESERVED ©
 THE DESIGN AND DETAIL OF THIS DRAWING IS THE PROPERTY OF
 AND MUST BE RETURNED ON DEMAND. IT IS ISSUED ON THE STRICT
 CONDITION THAT WITHOUT WRITTEN PERMISSION IT MUST NOT BE REPRODUCED,
 COPIED OR COMMUNICATED TO ANY THIRD PARTY NOR BE USED FOR ANY
 PURPOSE OTHER THAN THAT STATED IN THE PARTICULAR ENQUIRY, ORDER OR
 CONTRACT WITH WHICH IT IS ISSUED. THE RESERVATION OF COPYRIGHT IN THIS
 DRAWING IS NOT AFFECTED BY ANY ASSIGNMENT, TRANSFER OR
 DOCUMENT OF THE SUBJECT MATTER AS IT APPEARED AT THE RELEVANT DATE.

ITEM	PART NO.	ITEM DESCRIPTION	UL REQUIREMENT
24	2H1	WATER HEATER UL	
23	2C11	CURRENT TRANSFORMER UL	UL 508
22	311	TYCO 15HOLE 1-480711-0	UL 1977
21	212	TYCO 3HOLE 1-480701-0	UL 1977
20	211	TYCO 9HOLE 1-480707-0	UL 1977
19	1T2	TYCO 4HOLE 1-480703-0	UL 1977
18	1T1	TYCO 12HOLE 1-480709-0	UL 1977
17	1F4,2F2,2F3,2F4	216002P/F2.0A 250V 5x20(FUSED)	UL 248
16	2F5	ABB S20U K6A-1P(HIGH BREAKER MINI CURRENT CIRCUIT)	UL 489
15	2F1	ABB S20U K16A-1P(HIGH BREAKER MINI CURRENT CIRCUIT)	UL 489
14	1F3	ABB S20U K16A-1P(HIGH BREAKER MINI CURRENT CIRCUIT)	UL 489
13	1F2	ABB S20U K32A-1P(HIGH BREAKER MINI CURRENT CIRCUIT)	UL 489
12	1F1	ABB S20U K3A-1P(HIGH BREAKER MINI CURRENT CIRCUIT)	UL 489
11	2F6,2F7	216315P/F315A 250V 5x20(FUSED)	UL 248
10	1U2	DEFSEA7320 MKII MODULE	UL 508
09	1U1	BATTERY CHARGE ACC230V/DC24V	UL 1236
08	1L1	CANOPY LIGHT PD771WRR DC12V	
07	1S7	LDW WATER LEVEL SWITCH	
06	1S6	FLEXIBLE SENSOR	
05	1S3	FUEL SOLENOID	
04	1S2	EMERGENCY STOP ABB UL	UL 94
03	1S1	CANOPY LIGHT SWITCH	
02	1R1,1R2	ROCKWELL 700-HF6224/SCHEDDER 399FXBCI-24D DC24V 25A	UL 508
01	1R11,1R8,1R9	DRM270024L(T)RELAYAND RELAY N/C CONTACTOR	UL 508

ITEM	DESCRIPTION	QTY	UNIT	REMARKS
01	PE(16AWG Y/G)	0	PE	
02	PE(16AWG Y/G)	0	PE	
03	PE(16AWG Y/G)	0	PE	
04	48(16AWG BLACK)	0	48	
05	2(16AWG BLACK)	0	2	
06	2(16AWG BLACK)	0	2	
07	03(16AWG BLACK)	0	03	
08	3(16AWG BLACK)	0	3	
09	80(14AWG BLACK)	0	80	
10	N(80)(14AWG BLUE)	0	N(80)	
11	N(80)(14AWG BLUE)	0	N(80)	
12	81(14AWG BLACK)	0	81	
13	N(81)(14AWG BLUE)	0	N(81)	
14	82(14AWG BLACK)	0	82	
15	N(82)(14AWG BLUE)	0	N(82)	
16	83(14AWG BLACK)	0	83	
17	N(83)(14AWG BLUE)	0	N(83)	
18	84(14AWG BLACK)	0	84	
19	N(84)(14AWG BLUE)	0	N(84)	
20	85(14AWG BLACK)	0	85	
21	N(85)(14AWG BLUE)	0	N(85)	
22	86(14AWG BLACK)	0	86	
23	10(16AWG BLACK)	0	10	
24	94(16AWG BLACK)	0	94	
25	95(16AWG BLACK)	0	95	
26	96(16AWG BLACK)	0	96	
27	97(16AWG BLACK)	0	97	
28	98(16AWG BLACK)	0	98	
29	99(16AWG BLACK)	0	99	

⚠ Canopy Gen-set do not install emergency stop ISS button in start panel. ISS1 is optional emergency stop.
 ⚠ If or all Aksa USA UL gensets are using two wire start off of digital input 48 to start the genset up.
 ⚠ 1~6# Terminal model: Weidmuller ZDU 2.5/4AN UL(UL1059). 7~29# Terminal model: Weidmuller ZDU 2.5 UL(UL1059).

ORDER CODE:	SCALE: 1:1	MATERIAL:	QUANTITY:	WEIGHT:
2018 DATE NAME SIGNATURE DRAWING BY: HJ1.24 HELEN CONTROLLED BY: HJ1.24 TOM APPROVED BY: HJ1.24 SAMER DEPARTMENT: ENGINEERING		PART NO.: USED FOR: APP-DU1250/275 (JOHN DEERE 6090HF DC24V DSE7320MK11)		
PART NAME: START PANEL		PART NO.: DRAWING NO.: SP-12362082UL REVISION NO.: 04		
SIGN VARIATION: 3		LOCATION: PAGE 4-4		

APD-ULJ300 – 500

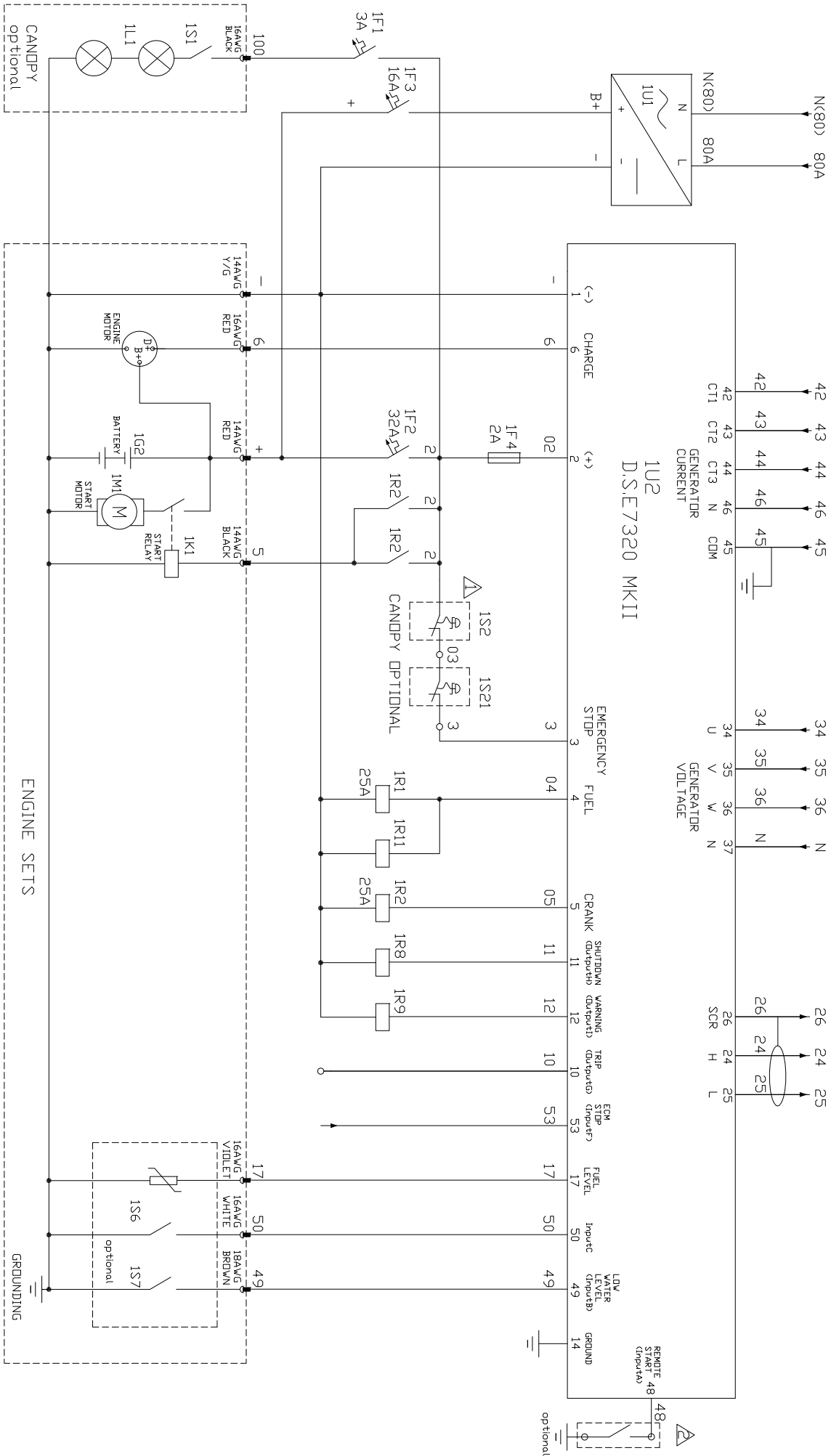

1U2
D.S.E7320 MKII

ENGINE SETS

COPYRIGHT RESERVED
 THE DESIGN AND DETAIL OF THIS DRAWING IS THE PROPERTY OF
 Also Power Generation (CHINA) Co., Ltd.
 AND MUST BE RETURNED ON DEMAND. IT IS ISSUED ON THE STRICT
 CONDITION THAT THE USER SHALL NOT REPRODUCE, COPY, RE-
 COPY OR COMMUNICATE TO ANY THIRD PARTY NOR BE USED FOR ANY
 PURPOSE OTHER THAN THAT STATED IN THE PARTICULAR ENQUIRY ORDER OR
 CONTRACT WITH WHICH IT IS ISSUED. THE RESERVATION OF COPYRIGHT IN THIS
 DOCUMENT EXTENDS FROM EACH DATE APPEARING THERE ON AND IN RESPECT
 OF THE SUBJECT MATTER AS IT APPEARED AT THE RELEVANT DATE.

ORDER CODE:	SCALE:	1:1	MATERIAL:	QUANTITY:	WEIGHT:
H Add running signal	2018.02.01	HELEN	2018	DATE	NAME
G Change water heater power	2017.12.13	LUQ	2018	DATE	NAME
F Change water heater circuit	2017.02.07	Huang	CONTROLLED BY 02.01	TOM	
E Change terminal 89A/98B to 20V	2016.12.26	CAOJUN	DEPARTMENT: 02.01	SAMER	
D Change terminal heater 88B/98B	2016.12.13	CAOJUN	DEPARTMENT: ENGINEERING		
C Change label, parts	2016.05.10	CAOJUN			
B Change DSE7320 MKII	2016.04.25	CAOJUN			
A Change start system DC24V	2016.03.29	CAOJUN			

USED FOR: APP-UJ300/350/400/500
 (JOHN DEERE 6090HF/6135HF DC24V DSE7320MKII)

PART NAME: START PANEL

PART NO.:
 DRAWING NO.: SP-12362086UL

REVISION NO.: 08

LOCATIONS:
 A4
 PAGE 1-4

A

B

C

D

1

2

3

4

5

6

3

4

5

6

7

8

9

10

11

12

13

14

15

16

17

18

19

20

21

22

23

24

25

26

27

28

29

30

31

32

33

34

35

36

37

38

39

40

41

42

43

44

45

46

47

48

49

50

51

52

53

54

55

56

57

58

59

60

61

62

63

64

65

66

67

68

69

70

71

72

73

74

75

76

77

AUTOMATIK TRANSFER PANDSU AUTOMATIC TRANSFER SWITCH

WATER HEAT
MAINS VOLTAGE
AC120V

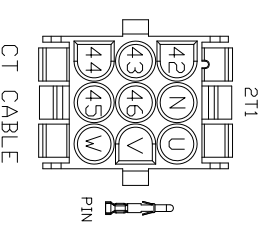
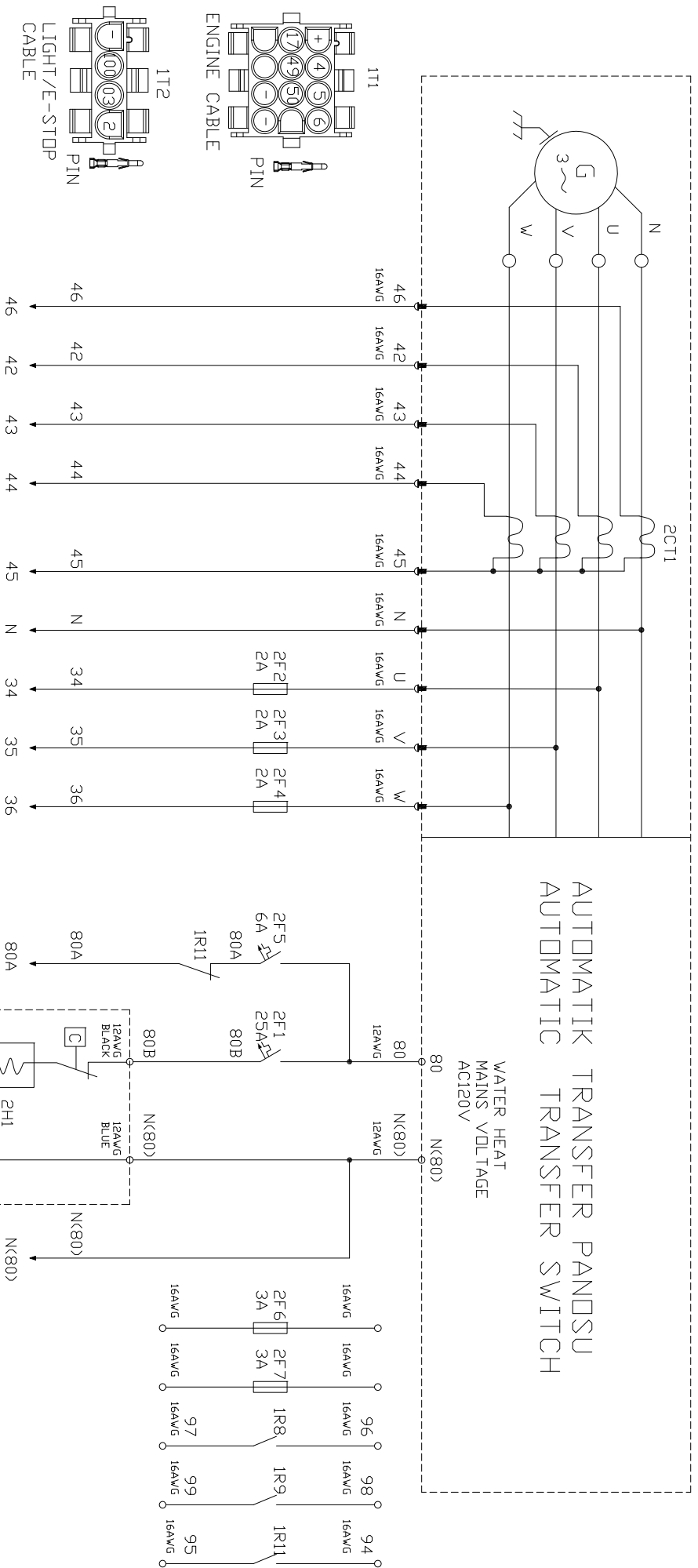

COPYRIGHT RESERVED

THE DESIGN AND DETAIL OF THIS DRAWING IS THE PROPERTY OF Asaka Power Generation (CHINA) CO. LTD. AND MUST BE USED ONLY FOR THE PROJECT AND NOT BE REPRODUCED, COPIED OR COMMUNICATED TO ANY THIRD PARTY NOR BE USED FOR ANY PURPOSE OTHER THAN THAT STATED IN THE PARTICULAR ENQUIRY ORDER OR CONTRACT WITH WHICH IT IS ISSUED. THE RESERVATION OF COPYRIGHT IN THIS DOCUMENT EXTENDS FROM EACH DATE APPEARING THERE ON AND IN RESPECT OF THE SUBJECT MATTER AS IT APPEARED AT THE RELEVANT DATE.

ORDER CODE:		SCALE: 1:1		MATERIAL:	QUANTITY:	WEIGHT:
H	Add running signal	2018.02.01	HELEN			
G	Change water heater power	2017.12.13				
F	Change water heater circuit	2017.02.07	LUQ			
E	Change terminal 89A/98B to 20A	2016.12.26	CAOKUN			
D	Change terminal heater 89B/98B	2016.12.13	CAOKUN			
C	Change panel layout	2016.05.10	CAOKUN			
B	Change DSE7320 MKII	2016.04.25	CAOKUN			
A	Change start system DC24V	2016.03.29	CAOKUN			
SIGN VARIATION:		DATE	NAME			
				ASAKA POWER GENERATION		
PART NAME:		DATE		SIGNATURE		
START PANEL		2018		HELEN		
USED FOR:		DRAWING NO.:				
APP-UJ300/350/400/500 (JOHN DERE 6090HF/6135HF DC24V DSE7320MKII)		SP 12362086UL				
PART NO.:		LOCATION:		PAGE		
				A4		
REVISION NO.: 08		DATE		PAGE		
				2-4		

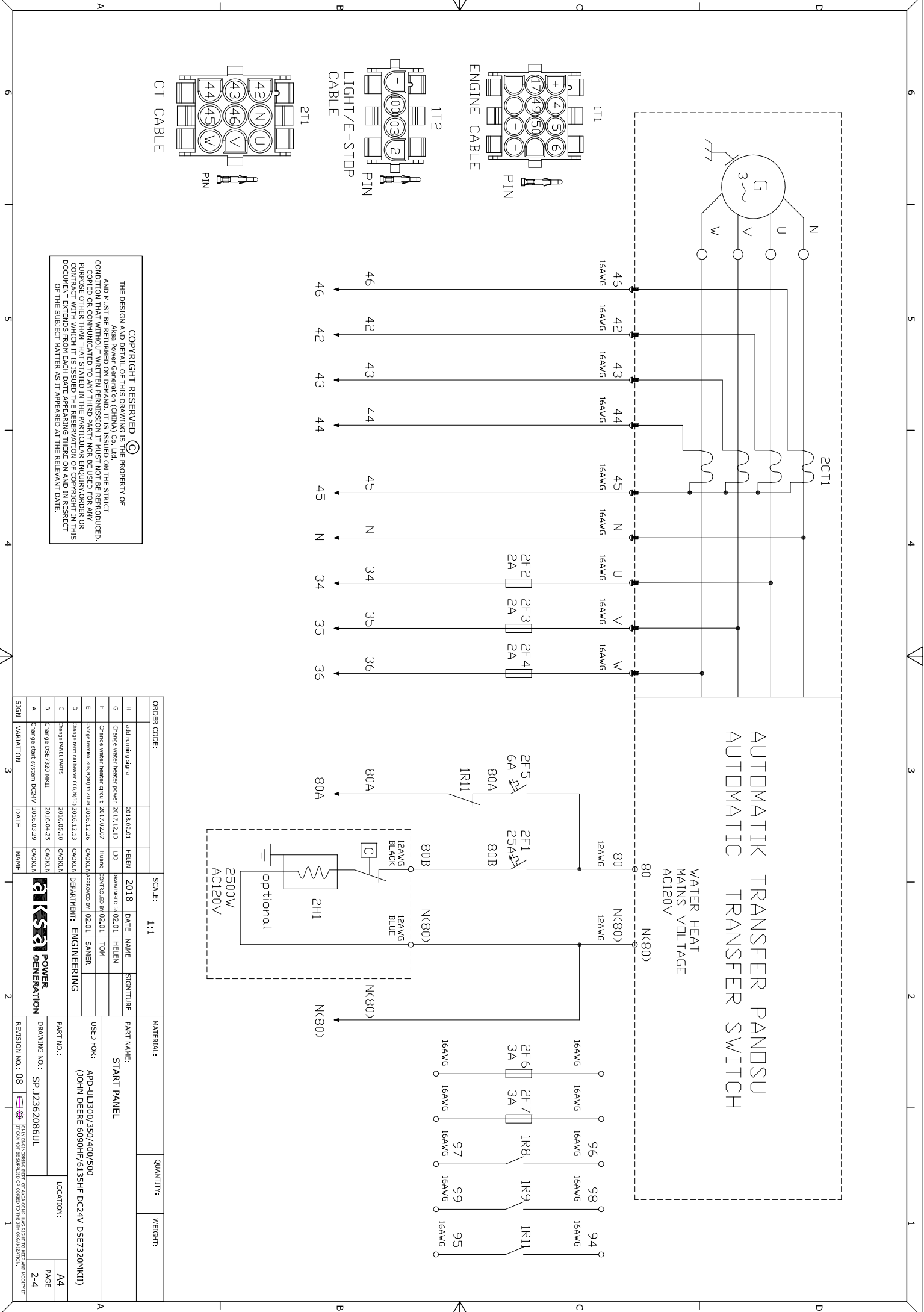

JOHN DEERE ECU(ENGINE CONTROL MODULE)

3U1

DIESEL ENGINE

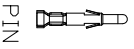
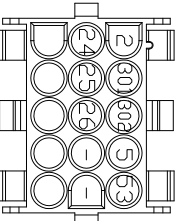
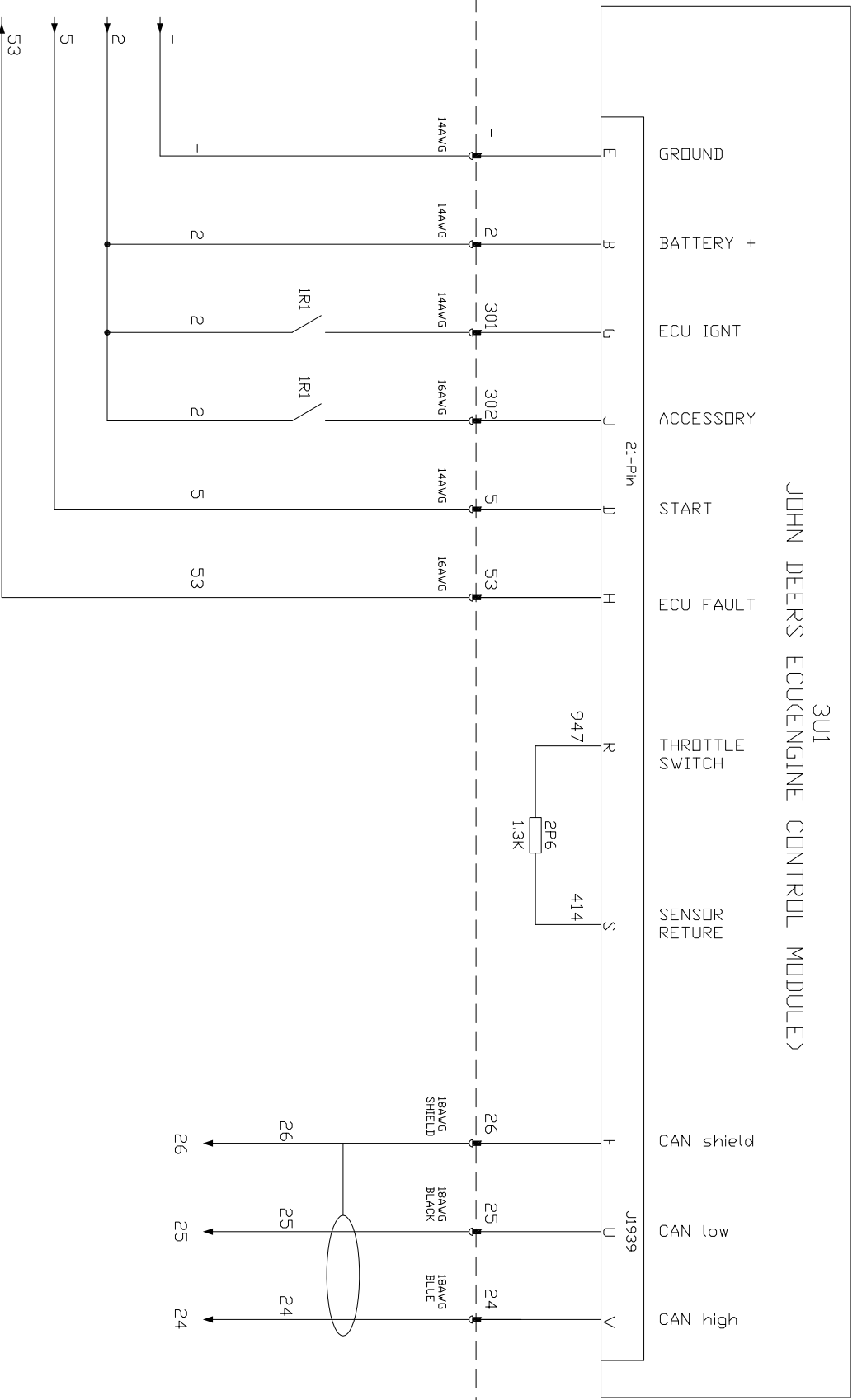

COPYRIGHT RESERVED

THE DESIGN AND DETAIL OF THIS DRAWING IS THE PROPERTY OF
 AND MUST BE KEPT IN CONFIDENTIALITY. IT IS NOT TO BE REPRODUCED,
 COPIED OR COMMUNICATED TO ANY THIRD PARTY NOR BE USED FOR ANY
 PURPOSE OTHER THAN THAT STATED IN THE PARTICULAR ENQUIRY, ORDER OR
 CONTRACT WITH WHICH IT IS ISSUED. THE RESERVATION OF COPYRIGHT IN THIS
 DOCUMENT EXTENDS FROM EACH DATE APPEARING THERE ON AND IN RESPECT
 OF THE SUBJECT MATTER AS IT APPEARED AT THE RELEVANT DATE.

ORDER CODE:		SCALE: 1:1		MATERIAL:		QUANTITY:		WEIGHT:	
H	Add running signal	2018.02.01	HELEN	2018	DATE	NAME	SIGNATURE	PART NAME: START PANEL	
G	Change water heater power	2017.12.13	LIU	2018.02.01	DATE	NAME	SIGNATURE	USED FOR: APD-UJ300/350/400/500 (JOHN DEERE 6090HF/6135HF DC24V DSE7320MK1D)	
F	Change water heater detail	2017.02.07	Huang	CONTROLLED BY 02.01	DATE	NAME	SIGNATURE	PART NO.: SP-12362086UL	
E	Change terminal 898,989 to 20V	2016.12.26	CAOKUN	DEPARTMENT: ENGINEERING	DATE	NAME	SIGNATURE	DRAWING NO.: SP-12362086UL	
D	Change terminal heater 889,890	2016.12.13	CAOKUN	DEPARTMENT: ENGINEERING	DATE	NAME	SIGNATURE	LOCATION:	
C	Change label, parts	2016.05.10	CAOKUN		DATE	NAME	SIGNATURE	PAGE A4	
B	Change DSE7320 MK1D	2016.04.28	CAOKUN		DATE	NAME	SIGNATURE	REVISION NO.: 08	
A	Change start system DC24V	2016.03.29	CAOKUN		DATE	NAME	SIGNATURE	3-4	

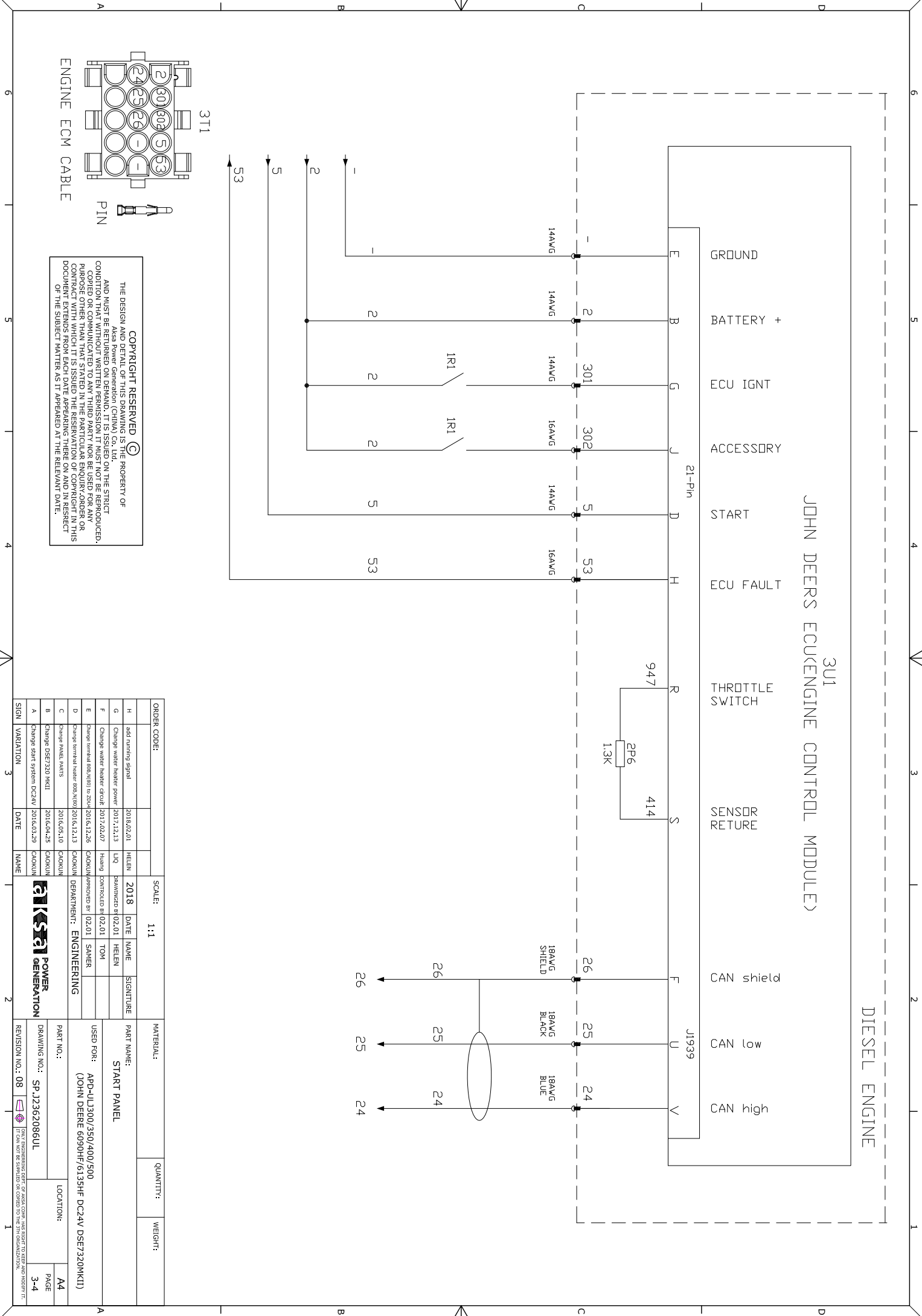

COPYRIGHT RESERVED

THE DESIGN AND DETAIL OF THIS DRAWING IS THE PROPERTY OF AND MUST BE RETURNED ON DEMAND. IT IS ISSUED ON THE STRICT CONDITION THAT WITHOUT WRITTEN PERMISSION IT MUST NOT BE REPRODUCED, COPIED OR COMMUNICATED TO ANY THIRD PARTY NOR BE USED FOR ANY PURPOSE OTHER THAN THAT STATED IN THE PARTICULAR ENQUIRY, ORDER OR CONTRACT WITH WHICH IT IS ISSUED. THE RESERVATION OF COPYRIGHT IN THIS DRAWING IS NOT WAIVED BY THE ISSUE OF THIS DRAWING. CONTACT THE SUBJECT MATTER AS IT APPEARED AT THE RELEVANT DATE.

80B(12AWG BLACK)	<input type="checkbox"/>	X	<input type="checkbox"/>	
80B	<input type="checkbox"/>	80B	<input type="checkbox"/>	
N(80)(12AWG BLUE)	<input type="checkbox"/>	N(80)	<input type="checkbox"/>	

WATER HEATER

PE(16AWG Y/G)	<input type="checkbox"/>	X	<input type="checkbox"/>		PE
PE(16AWG Y/G)	<input type="checkbox"/>	01	PE	<input type="checkbox"/>	PE
PE(16AWG Y/G)	<input type="checkbox"/>	02	PE	<input type="checkbox"/>	PE
48(16AWG BLACK)	<input type="checkbox"/>	03	PE	<input type="checkbox"/>	PE
2(16AWG BLACK)	<input type="checkbox"/>	04	48	<input type="checkbox"/>	48
2(16AWG BLACK)	<input type="checkbox"/>	05	2	<input type="checkbox"/>	2
03(16AWG BLACK)	<input type="checkbox"/>	06	2	<input type="checkbox"/>	2
3(16AWG BLACK)	<input type="checkbox"/>	07	03	<input type="checkbox"/>	03
80(12AWG BLACK)	<input type="checkbox"/>	08	3	<input type="checkbox"/>	3
N(80)(12AWG BLUE)	<input type="checkbox"/>	09	80	<input type="checkbox"/>	80
N(80)(12AWG BLUE)	<input type="checkbox"/>	10	N(80)	<input type="checkbox"/>	N(80)
8(14AWG BLACK)	<input type="checkbox"/>	11	N(80)	<input type="checkbox"/>	N(80)
N(81)(14AWG BLUE)	<input type="checkbox"/>	12	81	<input type="checkbox"/>	81
8(14AWG BLACK)	<input type="checkbox"/>	13	N(81)	<input type="checkbox"/>	N(81)
N(82)(14AWG BLUE)	<input type="checkbox"/>	14	82	<input type="checkbox"/>	82
8(14AWG BLACK)	<input type="checkbox"/>	15	N(82)	<input type="checkbox"/>	N(82)
N(83)(14AWG BLUE)	<input type="checkbox"/>	16	83	<input type="checkbox"/>	83
8(14AWG BLACK)	<input type="checkbox"/>	17	N(83)	<input type="checkbox"/>	N(83)
8(14AWG BLUE)	<input type="checkbox"/>	18	84	<input type="checkbox"/>	84
8(14AWG BLUE)	<input type="checkbox"/>	19	N(84)	<input type="checkbox"/>	N(84)
8(14AWG BLUE)	<input type="checkbox"/>	20	85	<input type="checkbox"/>	85
N(85)(14AWG BLUE)	<input type="checkbox"/>	21	N(85)	<input type="checkbox"/>	N(85)
8(14AWG BLACK)	<input type="checkbox"/>	22	86	<input type="checkbox"/>	86
10(16AWG BLACK)	<input type="checkbox"/>	23	10	<input type="checkbox"/>	10
9(16AWG BLACK)	<input type="checkbox"/>	24	94	<input type="checkbox"/>	94
9(16AWG BLACK)	<input type="checkbox"/>	25	95	<input type="checkbox"/>	95
9(16AWG BLACK)	<input type="checkbox"/>	26	96	<input type="checkbox"/>	96
9(16AWG BLACK)	<input type="checkbox"/>	27	97	<input type="checkbox"/>	97
9(16AWG BLACK)	<input type="checkbox"/>	28	98	<input type="checkbox"/>	98
9(16AWG BLACK)	<input type="checkbox"/>	29	99	<input type="checkbox"/>	99

- ⚠ :Canopy Gen-set do not install emergency stop ISE button in start panel ISE21 is optional emergency stop.
- ⚠ :For all Aksa USA UL gensets are using two wire start off of digital input 48 to start the genset up.
- ⚠ :1-6#Terminal model:Weidmuller ZDU 2/5/4AN UL(UL1059). 7,8,12-29#Terminal model:Weidmuller ZDU25 UL(UL1059).
- ⚠ :9-11,01-02#Terminal model:Weidmuller ZDU4 UL(UL1059).

22	2H1	WATER HEATER UL	UL	1977
21	2C11	CURRENT TRANSFORMER UL	UL	1977
20	311	TYCO 15HOLE 1-480711-0	UL	1977
19	211	TYCO 9HOLE 1-480707-0	UL	1977
18	1T2	TYCO 4HOLE 1-480703-0	UL	1977
17	1T1	TYCO 12HOLE 1-480709-0	UL	248
16	1F4,2F2,2F3,2F4	216002P/F2.0A 250V 5X20(FUSE)	UL	489
15	2F5	ABB 250U K5A-1P(HIGH BREAKER MINI CURRENT CIRCUIT)	UL	489
14	2F1	ABB 250U K5A-1P(HIGH BREAKER MINI CURRENT CIRCUIT)	UL	489
13	1F3	ABB 250U K16A-1P(HIGH BREAKER MINI CURRENT CIRCUIT)	UL	489
12	1F2	ABB 250U K2A-1P(HIGH BREAKER MINI CURRENT CIRCUIT)	UL	489
11	1F1	ABB 250U K2A-1P(HIGH BREAKER MINI CURRENT CIRCUIT)	UL	489
10	2F6,2F7	216315P/F3.15A 250V 5X20(FUSE)	UL	248
09	1U2	DEESEA7320 MKII MODUEL	UL	508
08	1U1	BATTERY CHARGE AC230V/DC24V	UL	1236
07	1L1	CANDPY LIGHT PD771WRR DC12V		
06	1S7	LDW WATER LEVEL SWITCH		
05	1S6	FEXIBLE SENSOR		
04	1S2	EMERGENCY STOP ABB UL	UL	94
03	1S1	CANDPY LIGHT SWITCH		
02	1R1,1R2	ROCKWELL 700-HF6224V/SCHIEDER 399FXBCI-24D DC24V 25A	UL	508
01	1R9,1R9,1R11	DRM270024L(TRELAVY)AND RELAY N/C CONTACTOR	UL	508
ITEM	PART NO.	ITEM DESCRIPTION	UL	REQUIREMENT

ORDER CODE: 1:1

H	add running signal	2018.02.01	HELEN	2018	DATE	NAME	SIGNATURE
G	Change water heater power	2017.12.13	LUQ	2018	DATE	NAME	SIGNATURE
F	Change water heater circuit	2017.02.07	Huang	CONTROLLED BY	02.01	TOM	
E	Change terminal block (80,100) to 200	2016.12.26	CAOKUN	DEPARTMENT:	ENGINEERING		
D	Change terminal header 800(N/80)	2016.12.13	CAOKUN				
C	Change panel parts	2016.05.10	CAOKUN				
B	Change DSE720 MKII	2016.04.28	CAOKUN				
A	Change start system DC24V	2016.03.29	CAOKUN				

SCALE: 1:1

MATERIAL: PART NAME: START PANEL

QUANTITY: WEIGHT:

USED FOR: APP-ULJ300/350/400/500 (JOHN DERE 6090HF/6135HF DC24V DSE7320MKII)

PART NO.: SP-12362086UL

DRAWING NO.: LOCATION: A4

REVISION NO.: 08

PAGE 4-4

ONLY ENGINEERING DEPT. OR ASKS CORP. HAS RIGHT TO KEEP AND MODIFY IT. IT CAN NOT BE SHARED OR COPIED TO THE 3TH ORGANIZATION.

APD-ULP9 - 30

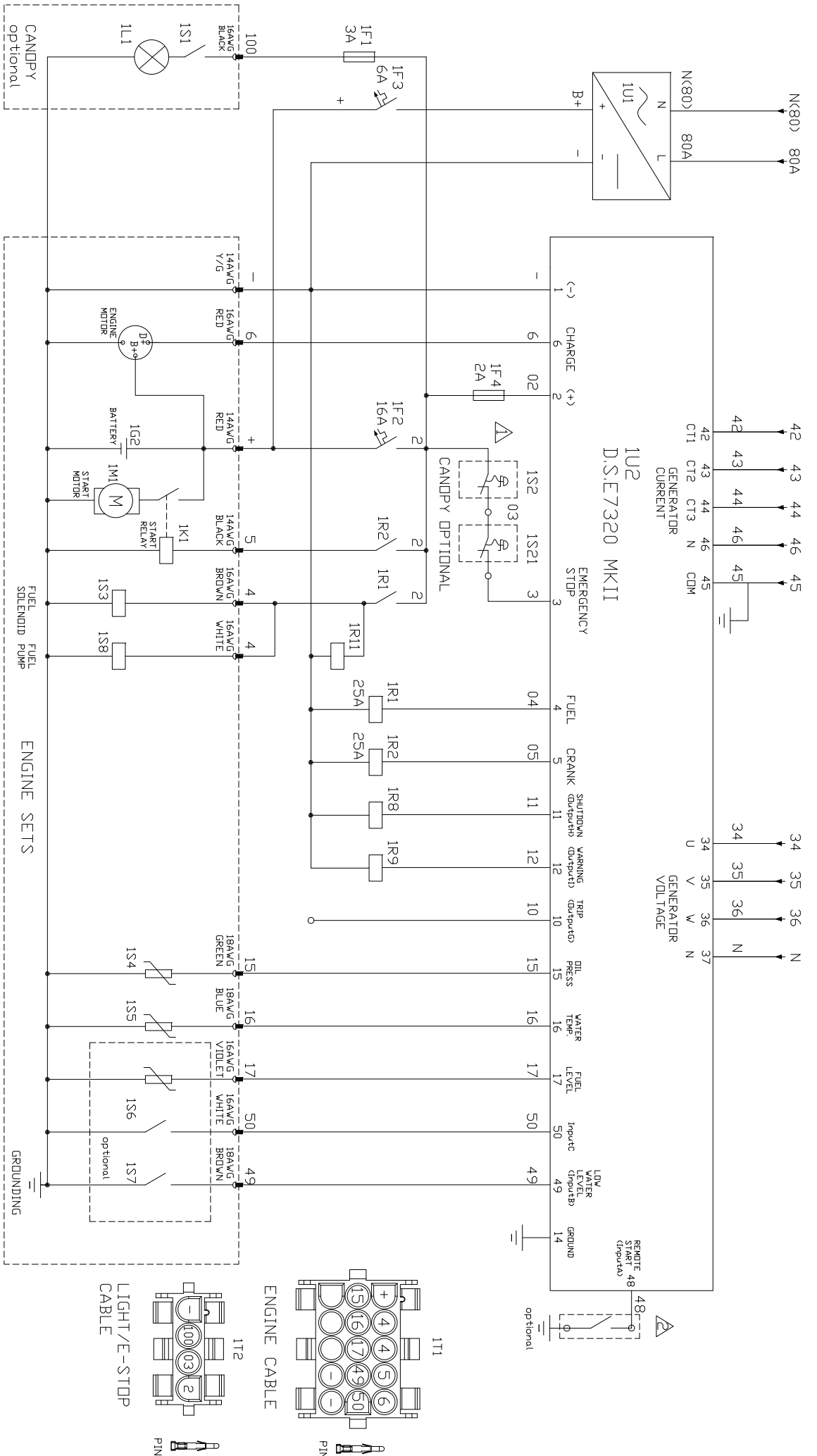

DSET320 MKII

COPYRIGHT RESERVED ©
 Also Power Generation (China) Co., Ltd.
 THE DESIGN AND DETAIL OF THIS DRAWING IS THE PROPERTY OF
 AND MUST BE RETURNED ON DEMAND. IT IS ISSUED ON THE STRICT
 CONFIDENTIALITY BASIS. IT IS NOT TO BE REPRODUCED, COPIED,
 COPIED OR COMMUNICATED TO ANY THIRD PARTY, NOR BE USED FOR ANY
 PURPOSE OTHER THAN THAT STATED IN THE PARTICULARS ENQUIRY, ORDER OR
 CONTRACT WITH WHICH IT IS ISSUED. THE RESERVATION OF COPYRIGHT IN THIS
 DOCUMENT EXTENDS FROM EACH DATE APPEARING THERE ON AND IN RESPECT
 OF THE SUBJECT MATTER AS IT APPEARED AT THE RELEVANT DATE.

ORDER CODE:	SCALE: 1:1	MATERIAL:	QUANTITY:	WEIGHT:

DATE	NAME	SIGNATURE
2015	CAOKUN	
DATE	NAME	SIGNATURE
10.25	TOMI	
DATE	NAME	SIGNATURE
10.25	TOTO	

DEPARTMENT:	ENGINEERING
PART NO.:	APD-ULP9/13/20/28/30/PREKINS 403D/404D DSET320
DRAWING NO.:	SP.P2362080 UL
REVISION NO.:	00

REVISION NO.:	00	LOCATION:	A4
			1-3

6 5 4 3 2 1

6 5 4 3 2 1

6 5 4 3 2 1

6 5 4 3 2 1

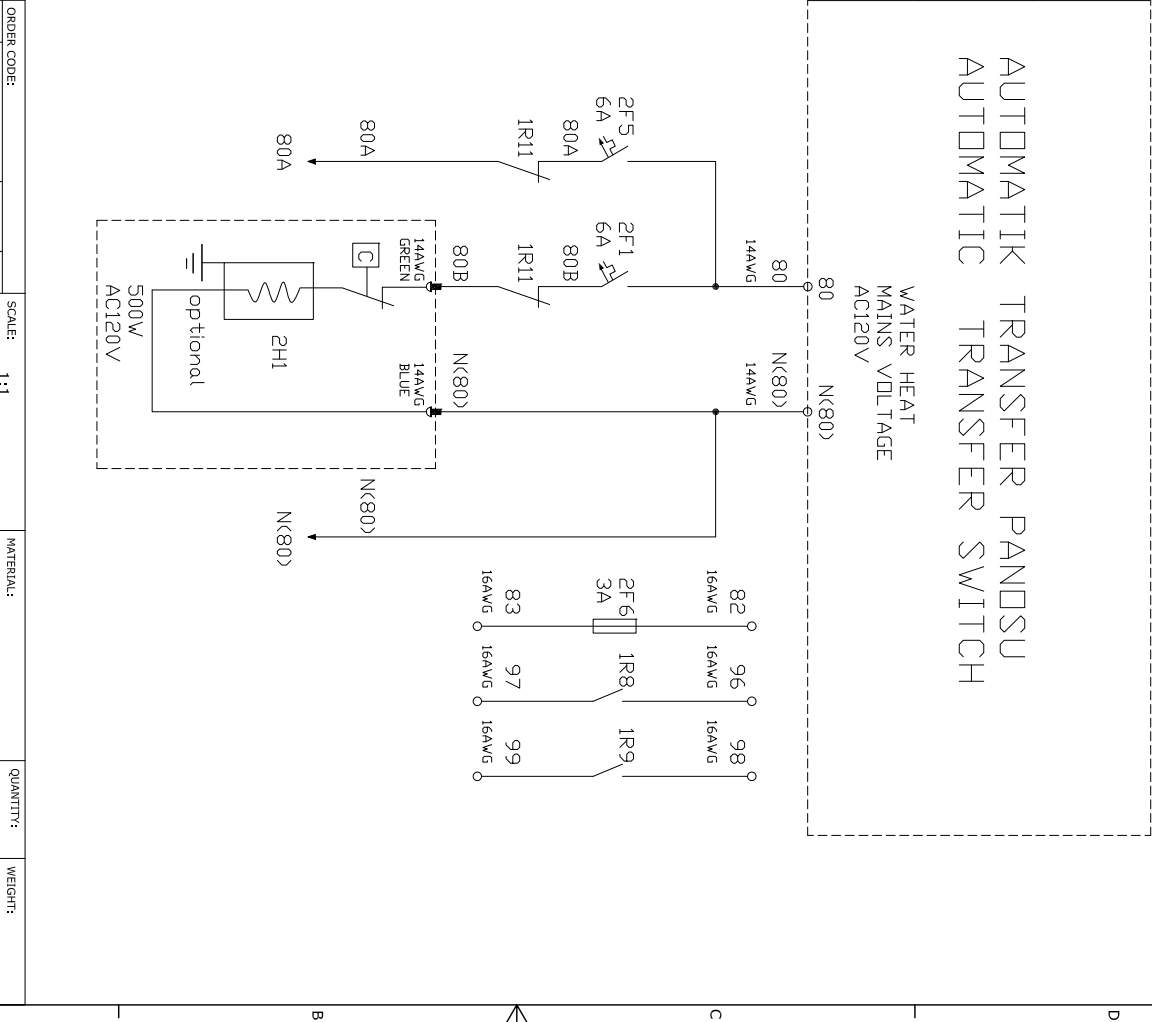
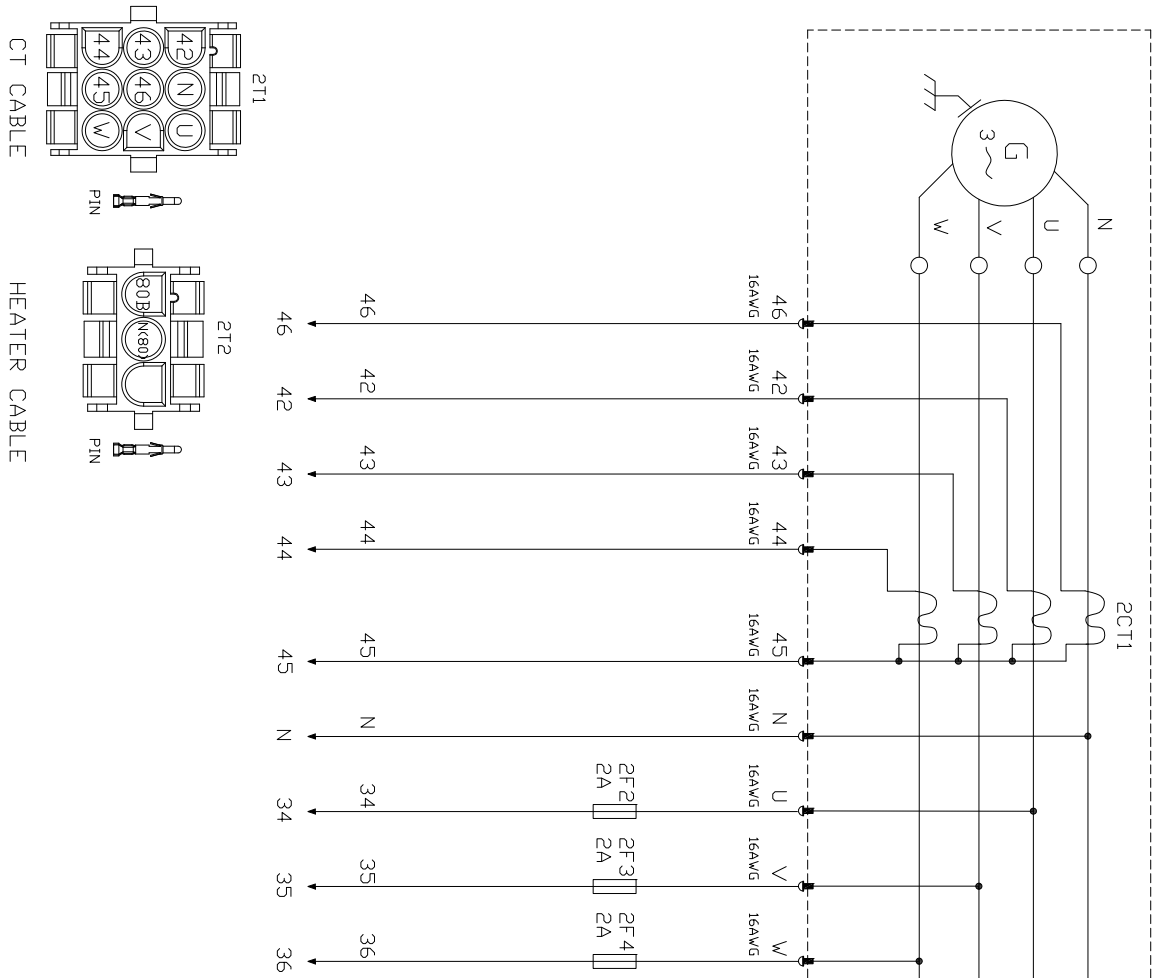

COPYRIGHT RESERVED
 THE DESIGN AND DETAIL OF THIS DRAWING IS THE PROPERTY OF ASEA POWER GENERATION (CHINA) CO., LTD. AND MUST BE KEPT CONFIDENTIAL. IT IS NOT TO BE REPRODUCED, COPIED OR COMMUNICATED TO ANY THIRD PARTY NOR BE USED FOR ANY PURPOSE OTHER THAN THAT STATED IN THE PARTICULAR ENQUIRY ORDER OR CONTRACT WITH WHICH IT IS ISSUED. THE RESERVATION OF COPYRIGHT IN THIS DOCUMENT EXTENDS FROM EACH DATE APPEARING THERE ON AND IN RESPECT OF THE SUBJECT MATTER AS IT APPEARED AT THE RELEVANT DATE.

ORDER CODE:		SCALE: 1:1		MATERIAL:		QUANTITY:	WEIGHT:
SIGN VARIATION:		DATE NAME SIGNATURE		PART NAME:			
DATE		2015 10.25 CAOKUN		START PANEL			
NAME		DRAWING BY: 10.25 TOMI		USED FOR:			
		APPROVED BY: 10.25 TOTO		APP-D-ULP9/13/20/28/30 (PERKINS 403D/404D DSE7320)			
		DEPARTMENT: ENGINEERING		PART NO.:			
		AKSEA POWER GENERATION		DRAWING NO.: SP.P2362080 UL		LOCATION:	A4
				REVISION NO.: 00			PAGE 2-3
				ONLY ENGINEERING DEPT. OF ASEA CORP. HAS RIGHT TO KEEP AND MODIFY IT. IT CAN NOT BE SPALTED OR COPIED TO THE 3RD ORGANIZATION.			

COPYRIGHT RESERVED

THE DESIGN AND DETAIL OF THIS DRAWING IS THE PROPERTY OF PERKINS POWER GENERATION INC. AND MUST BE RETURNED ON DEMAND. IT IS ISSUED ON THE STRICT CONDITION THAT WITHOUT WRITTEN PERMISSION IT MUST NOT BE REPRODUCED, COPIED OR COMMUNICATED TO ANY THIRD PARTY NOR BE USED FOR ANY PURPOSE OTHER THAN THAT STATED IN THE PARTICULAR ENQUIRY, ORDER OR CONTRACT WITH WHICH IT IS ISSUED. THE RESERVATION OF COPYRIGHT IN THIS DRAWING IS NOT AFFECTED BY THE DATE OF THE ISSUING OF THIS DRAWING. THE SUBJECT MATTER AS IT APPEARED AT THE RELEVANT DATE.

25	2H1	WATER HEATER UL	UL APPROVED (CS719)
24	2CT1	CURRENT TRANSFORMER UL	UL 1977
23	2T2	TYCD 3HOLE 1-480701-0	UL 1977
22	2T1	TYCD 9HOLE 1-480707-0	UL 1977
21	1T2	TYCD 4HOLE 1-480703-0	UL 1977
20	1T1	TYCD 15HOLE 1-480711-0	UL 1977
19	IF4,2F2,2F3,2F4	216002P/F2,0A 250V 5x20(FUSE)	UL 248
18	2F5	ABB S20U K6A-1P UL HIGH BREAKER MINI CURRENT CIRCUIT	UL 489
17	2F1	ABB S20U K6A-1P UL HIGH BREAKER MINI CURRENT CIRCUIT	UL 489
16	1F3	ABB S20U K6A-1P UL HIGH BREAKER MINI CURRENT CIRCUIT	UL 489
15	1F2	ABB S20U K6A-1P UL HIGH BREAKER MINI CURRENT CIRCUIT	UL 489
14	1F1,2F6	216315P/F315A 250V 5x20(FUSE)	UL 248
13	1U2	DEPSEA7320 MK1 MODUEL	UL 508
12	1U1	BATTERY CHARGE ACC230V/DC12V	UL 1236
11	1L1	CANOPY LIGHT PD771WRR DC12V	
10	1S8	FUEL PUMP	
09	1S7	LOW WATER LEVEL SWITCH	
08	1S6	FLEXIBLE SENSOR	
07	1S5	WATER TEMPERATURE SENSOR	
06	1S4	OIL PRESSURE SENSOR	
05	1S3	FUEL SOLENOID	
04	1S2	EMERGENCY STOP ABB UL	UL 94
03	1S1	CANOPY LIGHT SWITCH	
02	1R1,R2	ROCKWELL 700-HHF6Z12 UL DC12V 25A	UL 508
01	1R8,1R9,1R11	DRM270012LTKRELAYAND RELAY NC CONTACTOR	UL 508
ITEM	PART NO.	ITEM DESCRIPTION	UL REQUIREMENT

	X								
PE(16AWG Y/G)	0	01	PE	0	0	PE			
PE(16AWG Y/G)	0	02	PE	0	0	PE			
PE(16AWG Y/G)	0	03	PE	0	0	PE			
48(16AWG BLACK)	0	04	48	0	0	48			REMOTE START/STOP
2(16AWG BLACK)	0	05	2	0	0	2			
2(16AWG BLACK)	0	06	2	0	0	2			
03(16AWG BLACK)	0	07	03	0	0	03			OPTIONAL EMERGENCY
3(16AWG BLACK)	0	08	3	0	0	3			
80(14AWG BLACK)	0	09	80	0	0	80			WATER HEATER AND BATTERY CHARGER
N(80)(14AWG BLUE)	0	10	N(80)	0	0	N(80)			
N(80)(14AWG BLUE)	0	11	N(80)	0	0	N(80)			
81(14AWG BLACK)	0	12	81	0	0	81			ALT STRIP HEATER
N(81)(14AWG BLUE)	0	13	N(81)	0	0	N(81)			
82(14AWG BLACK)	0	14	82	0	0	82			AC LIGHT
N(82)(14AWG BLUE)	0	15	N(82)	0	0	N(82)			
83(14AWG BLACK)	0	16	83	0	0	83			BATTERY HEATER
N(83)(14AWG BLUE)	0	17	N(83)	0	0	N(83)			
84(14AWG BLACK)	0	18	84	0	0	84			OIL HEATER
N(84)(14AWG BLUE)	0	19	N(84)	0	0	N(84)			
85(14AWG BLACK)	0	20	85	0	0	85			RECEPTACLE
N(85)(14AWG BLUE)	0	21	N(85)	0	0	N(85)			
86(14AWG BLACK)	0	22	86	0	0	86			
10(16AWG BLACK)	0	23	10	0	0	10			
94(16AWG BLACK)	0	24	94	0	0	94			RUNNING
95(16AWG BLACK)	0	25	95	0	0	95			
96(16AWG BLACK)	0	26	96	0	0	96			SHUTDOWN
97(16AWG BLACK)	0	27	97	0	0	97			
98(16AWG BLACK)	0	28	98	0	0	98			WARNING
99(16AWG BLACK)	0	29	99	0	0	99			

- △: Canopy Gen-set do not install emergency stop 1S2 button in start panel. 1S21 is optional emergency stop.
- △: For all Aksa USA UL gensets are using two wire start off of digital input 48 to start the genset up.
- △: 1-6#Terminal model:Weidmuller ZDU 2.5/4AN UL(U.L1059). 7~29#Terminal model:Weidmuller ZDU2.5 UL(U.L1059).

ORDER CODE:		SCALE: 1:1	MATERIAL:	QUANTITY:	WEIGHT:
		2015 DATE NAME SIGNATURE	PART NAME:		
		DRAWING BY 10.25 CAOKUN	START PANEL		
		CONTROL BY 10.25 TOM	USED FOR:		
		APPROVED BY 10.25 TOTO	APP-ULP9/13/20/28/30(PERKINS 403D/404D DSE7320)		
		DEPARTMENT: ENGINEERING	PART NO.:	LOCATION:	A4
			DRAWING NO.: SP.P2362080 UL		PAGE
			REVISION NO.: 00		3-3



PERKINS POWER GENERATION
ONLY ENGINEERING DEPT. OF AKSA CORP. HAS RIGHT TO KEEP AND MODIFY THIS DRAWING. IT CAN NOT BE SPUN OFF OR GIVEN TO THE 3RD ORGANIZATION.

APD-ULP56

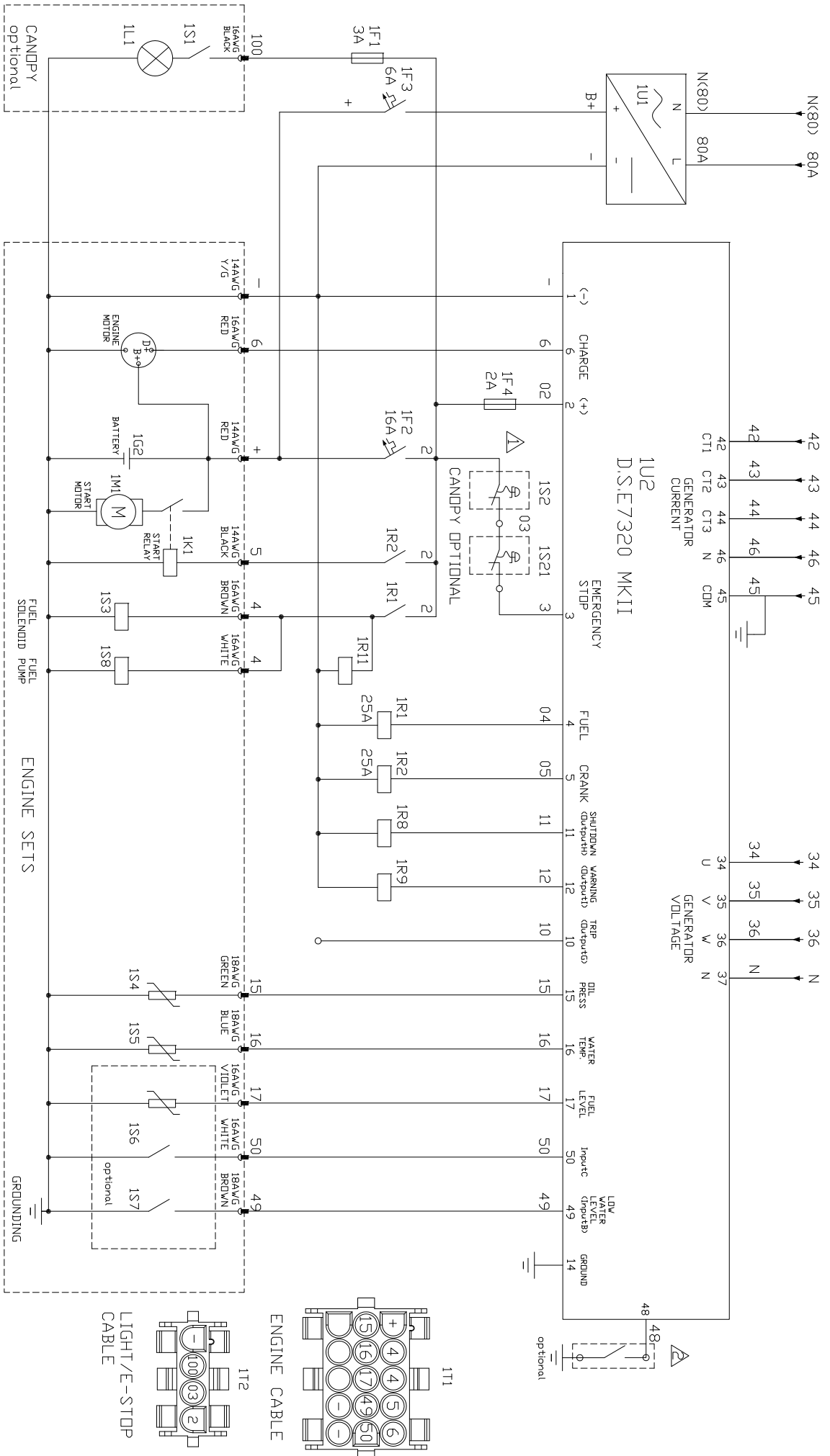

ENGINE SETS

FUEL SCHEMATIC

FUEL ENGINE SETS

OPTIONAL CANOPY

COPYRIGHT RESERVED

THE DESIGN AND DETAIL OF THIS DRAWING IS THE PROPERTY OF
 Also Power Generation (China) Co., Ltd.
 AND MUST BE RETURNED ON DEMAND. IT IS ISSUED ON THE STRICT
 CONDITION THAT IT IS TO BE USED ONLY FOR THE PURPOSE
 COPIED OR COMMUNICATED TO ANY THIRD PARTY. NO BE USED FOR ANY
 PURPOSE OTHER THAN THAT STATED IN THE PARTICULARS ENQUIRY, ORDER OR
 CONTRACT WITH WHICH IT IS ISSUED. THE RESERVATION OF COPYRIGHT IN THIS
 DOCUMENT EXTENDS FROM EACH DATE APPEARING THERE ON AND IN RESPECT
 OF THE SUBJECT MATTER AS IT APPEARED AT THE RELEVANT DATE.

ORDER CODE:	SCALE:	1:1	MATERIAL:	QUANTITY:	WEIGHT:
	DATE:	2015	DRAWING NO.:	SP.P2362081 UL	
	DATE:	10.25	CONTROLLED BY:	CAOKIN	
	DATE:	10.25	APPROVED BY:	TOMI	
	DATE:	10.25	TOTO		
	DATE:		DEPARTMENT:	ENGINEERING	
	DATE:		PART NO.:		A4
	DATE:		DRAWING NO.:	SP.P2362081 UL	1-3
	DATE:		REVISION NO.:	00	

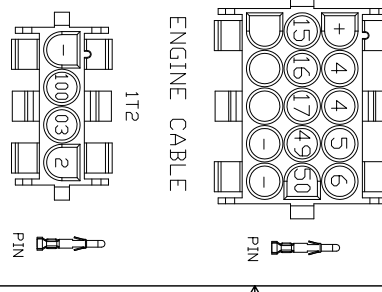

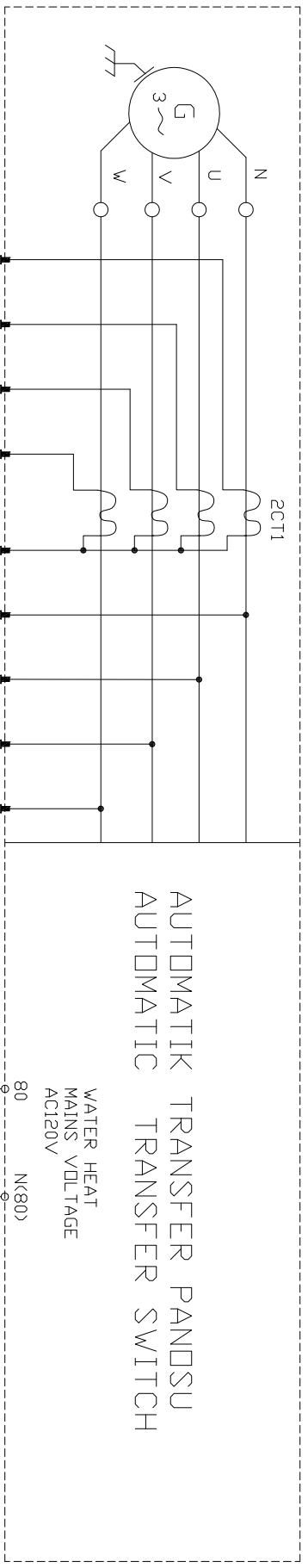

AUTOMATIK TRANSFER PANDSU
AUTOMATIC TRANSFER SWITCH

WATER HEAT
MAINS VOLTAGE
AC120V

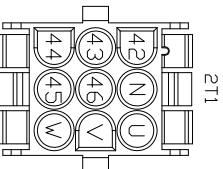
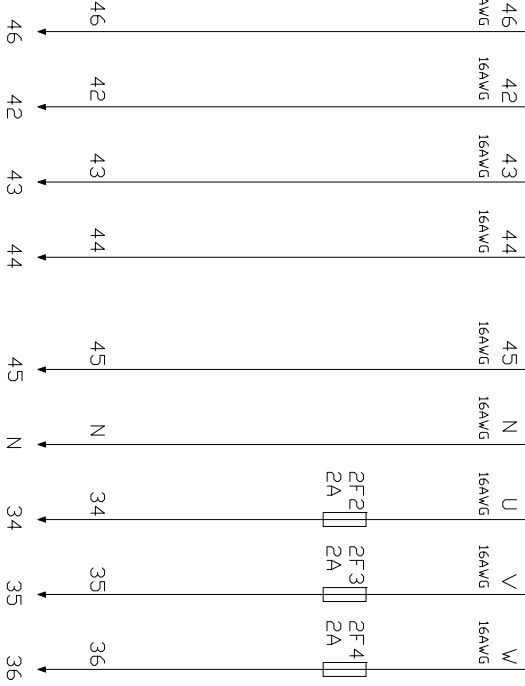

CT CABLE

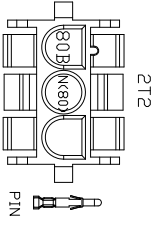

HEATER CABLE

COPYRIGHT RESERVED

THE DESIGN AND DETAIL OF THIS DRAWING IS THE PROPERTY OF
ASKA POWER GENERATION (CHINA) CO. LTD.
AND MUST BE KEPT IN CONFIDENTIALITY. NO PART OF THIS DRAWING
MAY BE REPRODUCED OR TRANSMITTED IN ANY FORM OR BY ANY
MEANS, ELECTRONIC OR MECHANICAL, INCLUDING PHOTOCOPYING,
RECORDING OR BY ANY INFORMATION STORAGE AND RETRIEVAL
SYSTEMS WITHOUT WRITTEN PERMISSION. THIS DOCUMENT IS
ISSUED FOR THE PURPOSE OF THE CONTRACT ONLY. IT IS NOT TO BE
COPIED OR COMMUNICATED TO ANY THIRD PARTY NOR BE USED FOR ANY
PURPOSE OTHER THAN THAT STATED IN THE PARTICULAR ENQUIRY ORDER OR
CONTRACT WITH WHICH IT IS ISSUED. THE RESERVATION OF COPYRIGHT IN THIS
DOCUMENT EXTENDS FROM EACH DATE APPEARING THERE ON AND IN RESPECT
OF THE SUBJECT MATTER AS IT APPEARED AT THE RELEVANT DATE.

ORDER CODE:		SCALE: 1:1		MATERIAL:		QUANTITY:	WEIGHT:
SIGN VARIATION:		DATE NAME		SIGNATURE			
		2015		DRAWN BY 10.25 CAOKUN		PART NAME: START PANEL	
				CONTROL BY 10.25 TOMI		USED FOR: APD-ULP56(PERKINS 1104D-44TG1 DSE7320)	
				APPROVED BY 10.25 TOTU		PART NO.:	
				DEPARTMENT: ENGINEERING		DRAWING NO.: SP.P2362081 UL	
						REVISION NO.: 00	
						LOCATION:	
						PAGE 2-3	
						A4	



ASKA POWER GENERATION (CHINA) CO. LTD. HAS THE RIGHT TO KEEP AND MODIFY THIS DOCUMENT WITHOUT BEING RESPONSIBLE FOR ANY DAMAGE TO THE ORIGINAL DOCUMENT. IT CAN NOT BE SPREAD OR COPIED TO THE 3TH ORGANIZATION.

COPYRIGHT RESERVED

THE DESIGN AND DETAIL OF THIS DRAWING IS THE PROPERTY OF
 AND MUST BE RETURNED ON DEMAND. IT IS ISSUED ON THE STRICT
 CONDITION THAT WITHOUT WRITTEN PERMISSION IT MUST NOT BE REPRODUCED,
 COPIED OR COMMUNICATED TO ANY THIRD PARTY NOR BE USED FOR ANY
 PURPOSE OTHER THAN THAT STATED IN THE PARTICULAR ENQUIRY, ORDER OR
 CONTRACT WITH WHICH IT IS ISSUED. THE RESERVATION OF COPYRIGHT IN THIS
 DRAWING IS RESERVED AND WILL BE MAINTAINED AND THE BELIEVED DATE
 OF THE SUBJECT MATTER AS IT APPEARED AT THE BELIEVED DATE.

ITEM	PART NO.	ITEM DESCRIPTION	UL REQUIREMENT
25	2H1	WATER HEATER UL	UL APPROVED (E719)
24	2CT1	CURRENT TRANSFORMER UL	UL 1977
23	2T2	TYCD 3HOLE 1-480701-0	UL 1977
22	2T1	TYCD 9HOLE 1-480707-0	UL 1977
21	1T2	TYCD 4HOLE 1-480703-0	UL 1977
20	1T1	TYCD 1SHOLE 1-480711-0	UL 1977
19	IF4,2F2,2F3,2F4	216002P/F2,0A 250V 5x20(FUSE)	UL 248
18	2F5	ABB S20U K6A-1P UL HIGH BREAKER MINI CURRENT CIRCUIT	UL 489
17	2F1	ABB S20U K6A-1P UL HIGH BREAKER MINI CURRENT CIRCUIT	UL 489
16	1F3	ABB S20U K6A-1P UL HIGH BREAKER MINI CURRENT CIRCUIT	UL 489
15	1F2	ABB S20U K6A-1P UL HIGH BREAKER MINI CURRENT CIRCUIT	UL 489
14	1F1,2F6	216315P/F315A 250V 5x20(FUSE)	UL 248
13	1U2	DEPSEA7320 MKII MODULE	UL 508
12	1U1	BATTERY CHARGE ACC230V/DC12V	UL 1236
11	1L1	CANOPY LIGHT PD771WRR DC12V	
10	1S8	FUEL PUMP	
09	1S7	LOW WATER LEVEL SWITCH	
08	1S6	FLEXIBLE SENSOR	
07	1S5	WATER TEMPERATURE SENSOR	
06	1S4	OIL PRESSURE SENSOR	
05	1S3	FUEL SOLENOID	
04	1S2	EMERGENCY STOP ABB UL	UL 94
03	1S1	CANOPY LIGHT SWITCH	
02	1R1,R2	ROCKWELL 700-HHF6R212 UL DC12V 25A	UL 508
01	1R8,1R9,1R11	DRM270012LTKRELAYAND RELAY NC CONTACTOR	UL 508

ITEM	DESCRIPTION	QTY	UNIT	REMARKS
01	PE(16AWG Y/G)	0	PE	
02	PE(16AWG Y/G)	0	PE	
03	PE(16AWG Y/G)	0	PE	
04	48(16AWG BLACK)	0	48	
05	2(16AWG BLACK)	0	2	
06	2(16AWG BLACK)	0	2	
07	03(16AWG BLACK)	0	03	
08	3(16AWG BLACK)	0	3	
09	80(14AWG BLACK)	0	80	
10	N(80)(14AWG BLUE)	0	N(80)	
11	N(80)(14AWG BLUE)	0	N(80)	
12	81(14AWG BLACK)	0	81	
13	N(81)(14AWG BLUE)	0	N(81)	
14	82(14AWG BLACK)	0	82	
15	N(82)(14AWG BLUE)	0	N(82)	
16	83(14AWG BLACK)	0	83	
17	N(83)(14AWG BLUE)	0	N(83)	
18	84(14AWG BLACK)	0	84	
19	N(84)(14AWG BLUE)	0	N(84)	
20	85(14AWG BLACK)	0	85	
21	N(85)(14AWG BLUE)	0	N(85)	
22	86(14AWG BLACK)	0	86	
23	10(16AWG BLACK)	0	10	
24	94(16AWG BLACK)	0	94	
25	95(16AWG BLACK)	0	95	
26	96(16AWG BLACK)	0	96	
27	97(16AWG BLACK)	0	97	
28	98(16AWG BLACK)	0	98	
29	99(16AWG BLACK)	0	99	

△: Canopy Gen-set do not install emergency stop 1S2 button in start panel. 1S21 is optional emergency stop.
 △: For all Aksa USA UL gensets are using two wire start off of digital input 48 to start the genset up.
 △: 1-6#Terminal model: Weidmuller ZDU 2.5/4AN UL(U1059). 7-29#Terminal model: Weidmuller ZDU2.5 UL(U1059).

ORDER CODE:	SCALE: 1:1	MATERIAL:	QUANTITY:	WEIGHT:
2015	DATE: 10.25	DRAWING NO.: SP.P2362081 UL	PART NO.:	APP-D-UP56(PERKINS 1104D-44TG1 DSE7320)
CONTROLLED BY: 10.25	TOKI	REVISION NO.: 00	LOCATION:	A4
APPROVED BY: 10.25	TOKI	DRAWING NO.: SP.P2362081 UL		PAGE 3-3
DEPARTMENT: ENGINEERING		PART NO.:		
		DRAWING NO.:		
		REVISION NO.:		



AKSA POWER GENERATION
 ONLY ENGINEERING DEPT. OF AKSA CORP. HAS RIGHT TO KEEP AND MODIFY IT.
 IT CAN NOT BE SHARDED OR COPIED TO THE 3RD ORGANIZATION.

APD-ULP65 - 100

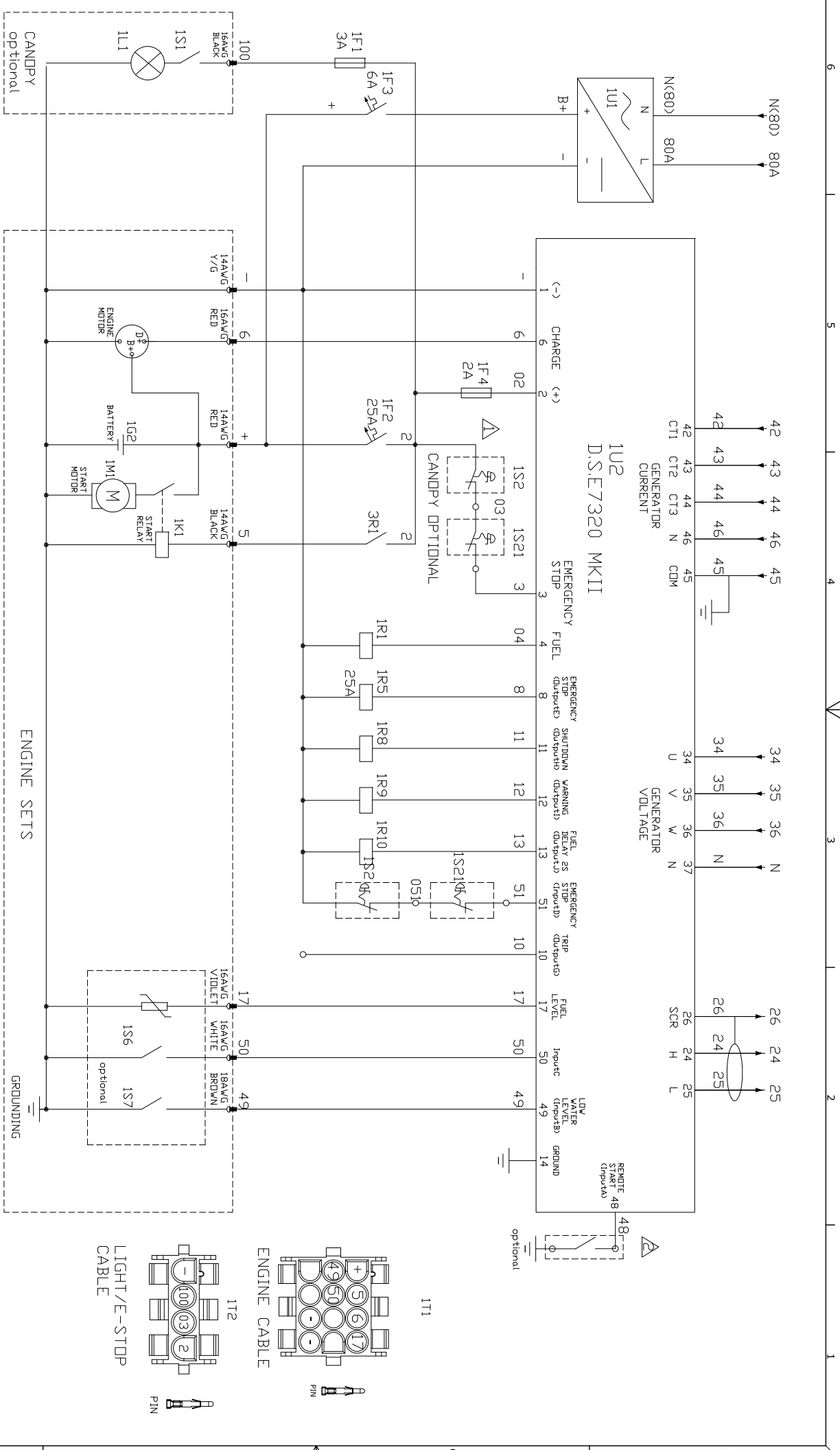

1U2
D.S.E7320 MKII

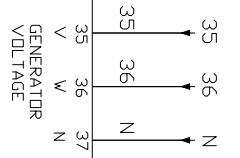
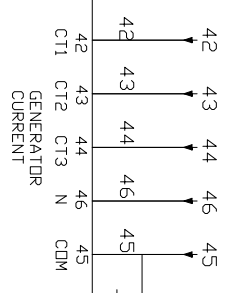

ENGINE START (Input to)



1T1

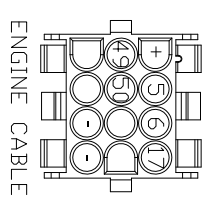

ENGINE CABLE

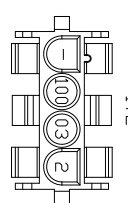

LIGHT/E-STOP CABLE

ENGINE SETS

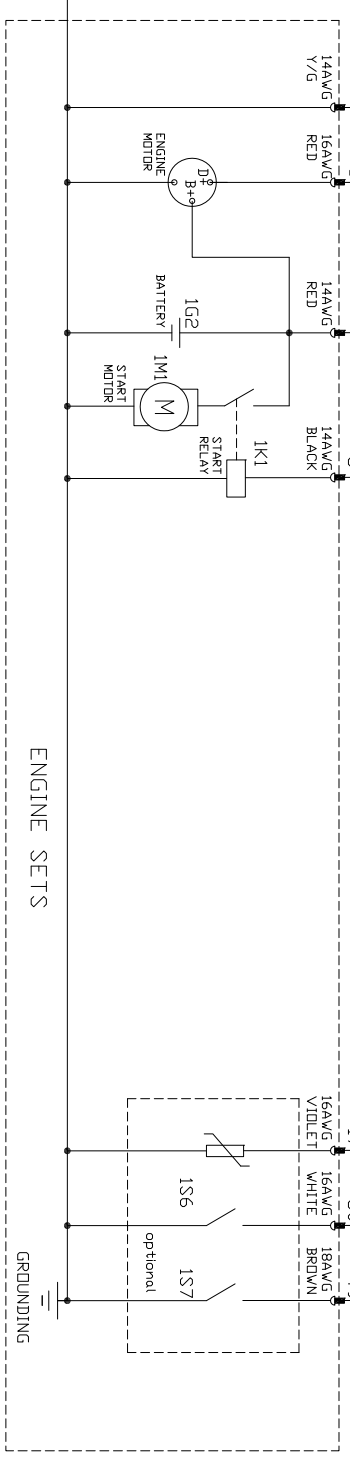
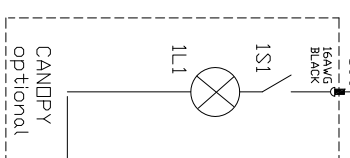

GROUNDING

ORDER CODE:	SCALE: 1:1	MATERIAL:	QUANTITY:	WEIGHT:

DATE NAME	SIGNATURE	PART NAME:	START PANEL
2015	CAOKIN		
DRAWING NO.: SP.P2362082 UL			
REVISION NO.: 00			

COPYRIGHT RESERVED
 THE DESIGN AND DETAIL OF THIS DRAWING IS THE PROPERTY OF
 Also Power Generation (China) Co., Ltd.
 AND MUST BE RETURNED ON DEMAND. IT IS ISSUED ON THE STRICT
 CONDITION THAT THE USER SHALL NOT REPRODUCE, COPY, RE-
 COPY OR COMMUNICATED TO ANY THIRD PARTY. NOT BE USED FOR ANY
 PURPOSE OTHER THAN THAT STATED IN THE PARTICULAR ENQUIRY, ORDER OR
 CONTRACT WITH WHICH IT IS ISSUED. THE RESERVATION OF COPYRIGHT IN THIS
 DOCUMENT EXTENDS FROM EACH DATE APPEARING THERE ON AND IN RESPECT
 OF THE SUBJECT MATTER AS IT APPEARED AT THE RELEVANT DATE.

DEPARTMENT: ENGINEERING	APPROVED BY: 10.25	TOTAL	USED FOR: APD-ULP65/82/100 (PERKINS 1104D-E44 DSE7320)
LOCATION: A4			
PAGE 1-4			

AUTOMATIK TRANSFER PANDSU AUTOMATIC TRANSFER SWITCH

WATER HEAT
MAINS VOLTAGE
AC120V

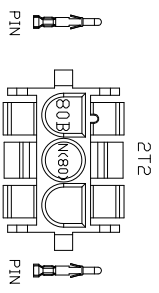
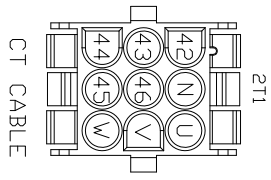
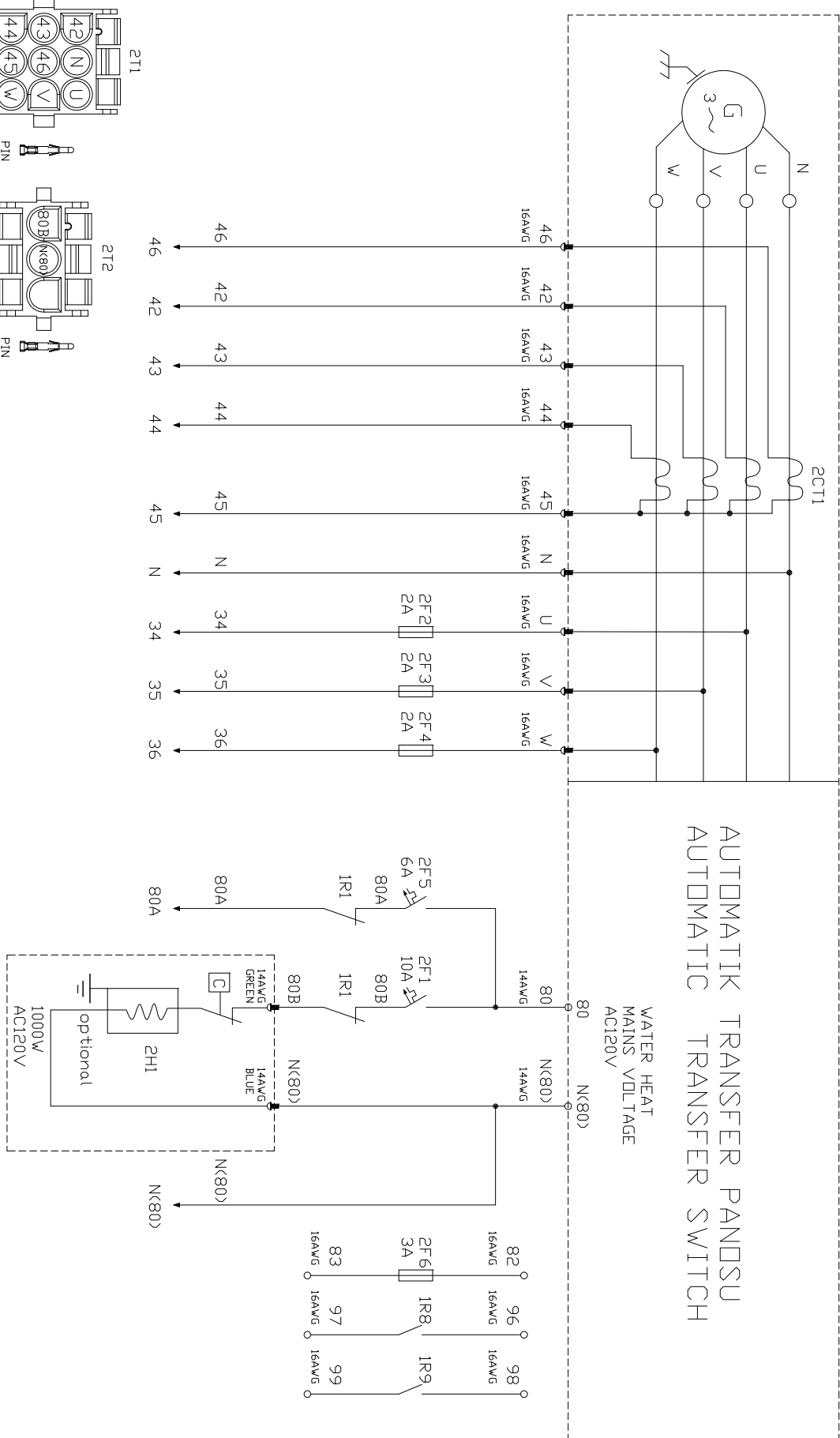

COPYRIGHT RESERVED

ASKA POWER GENERATION (CHINA) CO., LTD.
AND MUST BE REPRODUCED WITH THE WRITTEN PERMISSION OF ASKA POWER GENERATION (CHINA) CO., LTD.
THE DESIGN AND DETAIL OF THIS DRAWING IS THE PROPERTY OF ASKA POWER GENERATION (CHINA) CO., LTD. ANY REPRODUCTION, COPIED OR COMMUNICATED TO ANY THIRD PARTY, NOT BE USED FOR ANY PURPOSE OTHER THAN THAT STATED IN THE PARTICULAR ENQUIRY ORDER OR CONTRACT WITH WHICH IT IS ISSUED. THE RESERVATION OF COPYRIGHT IN THIS DOCUMENT EXTENDS FROM EACH DATE APPEARING THERE ON AND IN RESPECT OF THE SUBJECT MATTER AS IT APPEARED AT THE RELEVANT DATE.

ORDER CODE:		SCALE: 1:1		MATERIAL:		QUANTITY:		WEIGHT:	
SIGN VARIATION:		DATE NAME SIGNATURE		PART NAME: START PANEL		PART NO.:		PAGE A4	
DATE		DRAWING BY 10.25 CAOKUN		USED FOR: APD-ULP65/82/100(PERKINS 1104D-E44 DSE7320)		DRAWING NO.: SP.P2362082 UL		PAGE 2-4	
		CONTROLLED BY 10.25 TOM		DEPARTMENT: ENGINEERING		REVISION NO.: 00		LOCATION:	
		APPROVED BY 10.25 TOTO		REVISION NO.: 00		DRAWING NO.: SP.P2362082 UL			
		DEPARTMENT: ENGINEERING		REVISION NO.: 00		DRAWING NO.: SP.P2362082 UL			
		DRAWING NO.: SP.P2362082 UL		REVISION NO.: 00		DRAWING NO.: SP.P2362082 UL			
		DRAWING NO.: SP.P2362082 UL		REVISION NO.: 00		DRAWING NO.: SP.P2362082 UL			
		DRAWING NO.: SP.P2362082 UL		REVISION NO.: 00		DRAWING NO.: SP.P2362082 UL			

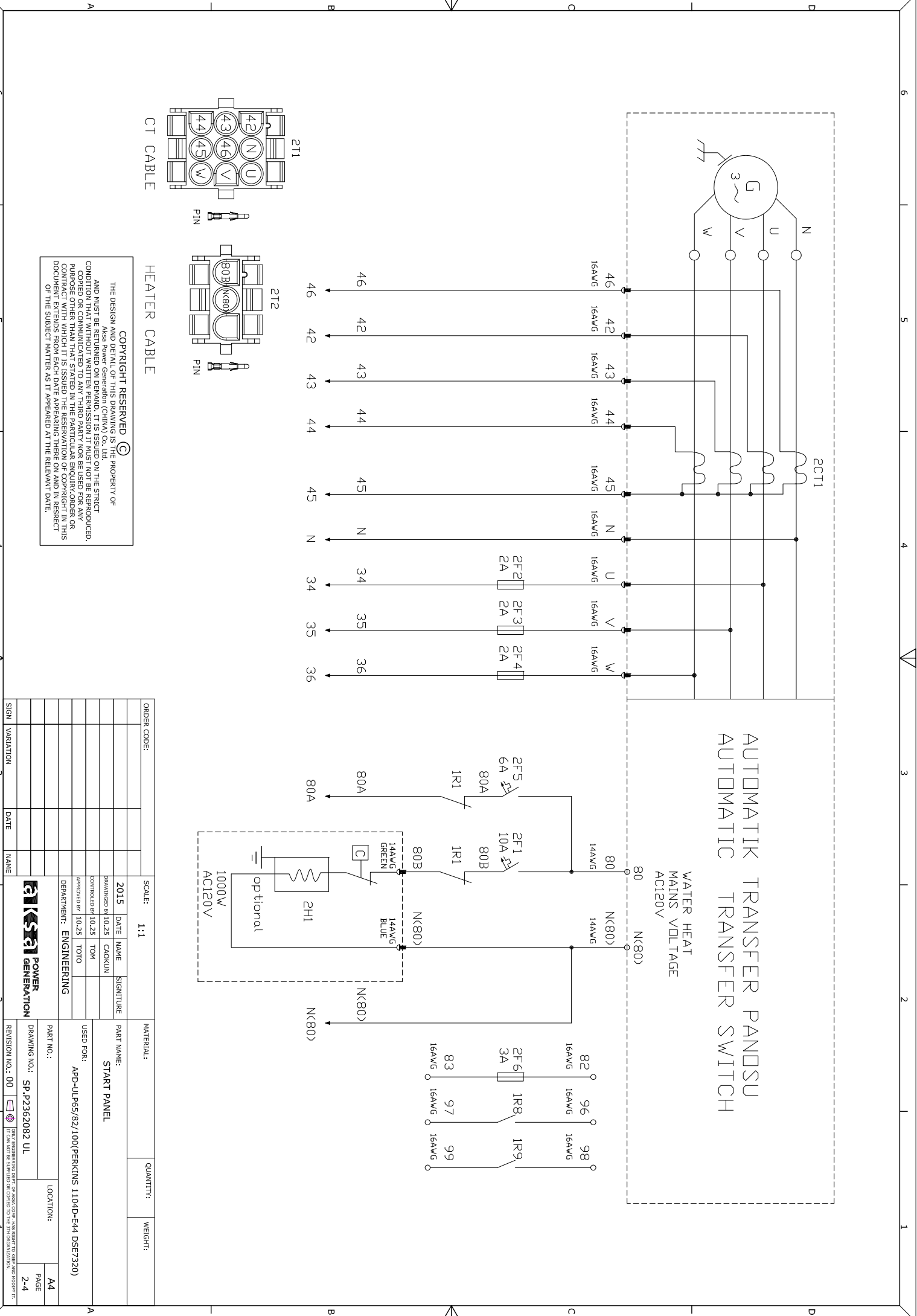

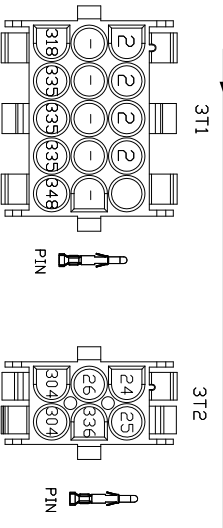
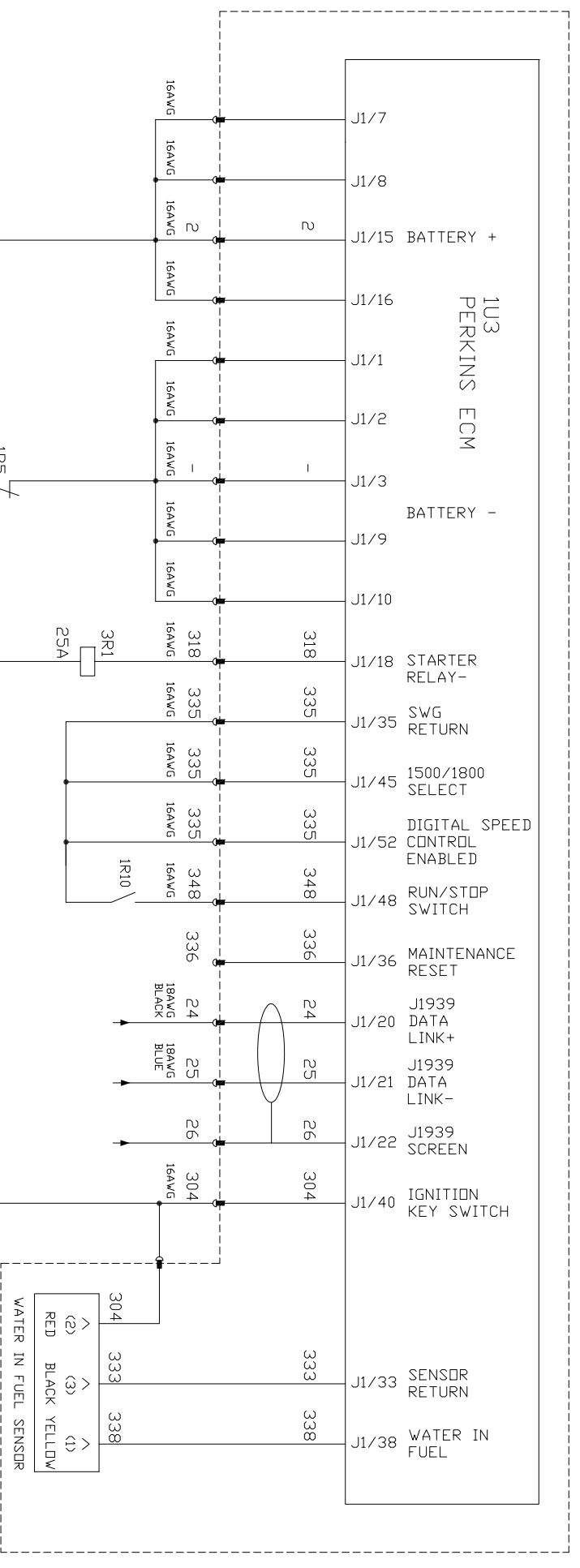

ENGINE ECM CABLE

COPYRIGHT RESERVED ©
 THE DESIGN AND DETAIL OF THIS DRAWING IS THE PROPERTY OF
 Aisa Power Generation (CHINA) CO., LTD.
 AND MUST BE USED ONLY FOR THE PURPOSES AND UNDER THE STRICT
 CONDITION THAT WITHOUT WRITTEN PERMISSION, IT MUST NOT BE REPRODUCED,
 COPIED OR COMMUNICATED TO ANY THIRD PARTY NOR BE USED FOR ANY
 PURPOSE OTHER THAN THAT STATED IN THE PARTICULAR ENQUIRY ORDER OR
 CONTRACT WITH WHICH IT IS ISSUED. THE RESERVATION OF COPYRIGHT IN THIS
 DOCUMENT EXTENDS FROM EACH DATE APPEARING THERE ON AND IN RESPECT
 OF THE SUBJECT MATTER AS IT APPEARED AT THE RELEVANT DATE.

ORDER CODE:	SCALE: 1:1	MATERIAL:	QUANTITY:	WEIGHT:
	DATE NAME SIGNATURE	PART NAME:		
	2015 CAOKUN	START PANEL		
	DRAWING NO.: 10.25 TOM	USED FOR: APD-UIP65/82/100 (PERKINS 1104D-E44 DSE7320)		
	CONTROLLED BY: 10.25 TOM	DRAWING NO.: SP.P2362082 UL		
	APPROVED BY: 10.25 TOTO	REVISION NO.: 00		
	DEPARTMENT: ENGINEERING			
SIGN VARIATION:	DATE NAME	PART NO.:	LOCATION:	PAGE
				A4
				3-4

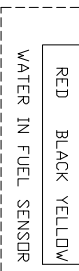

COPYRIGHT RESERVED

THE DESIGN AND DETAIL OF THIS DRAWING IS THE PROPERTY OF
 AND MUST BE RETURNED ON DEMAND. IT IS ISSUED ON THE STRICT
 CONDITION THAT WITHOUT WRITTEN PERMISSION IT MUST NOT BE REPRODUCED,
 COPIED OR COMMUNICATED TO ANY THIRD PARTY NOR BE USED FOR ANY
 PURPOSE OTHER THAN THAT STATED IN THE PARTICULAR ENQUIRY, ORDER OR
 CONTRACT WITH WHICH IT IS ISSUED. THE RESERVATION OF COPYRIGHT IN THIS
 DRAWING IS RESERVED AND THE DRAWING IS NOT TO BE REPRODUCED OR
 TRANSMITTED IN ANY FORM OR BY ANY MEANS, ELECTRONIC OR MECHANICAL,
 INCLUDING PHOTOCOPYING, RECORDING, OR BY ANY INFORMATION STORAGE AND
 RETRIEVAL SYSTEM, WITHOUT PERMISSION IN WRITING FROM THE DRAWING OFFICE.
 OF THE SUBJECT MATTER AS IT APPEARED AT THE RELEVANT DATE.

22	2H1	WATER HEATER UL	UL Approved (ANSI/IEEE CAN/ULC)
22	2C11	CURRENT TRANSFORMER UL	UL 1977
21	312	TYCD 6HOLE 1-480705-0	UL 1977
20	311	TYCD 15HOLE 1-480711-0	UL 1977
19	212	TYCD 3HOLE 1-480701-0	UL 1977
18	211	TYCD 9HOLE 1-480707-0	UL 1977
17	1T2	TYCD 4HOLE 1-480703-0	UL 1977
16	1T1	TYCD 12HOLE 1-480709-0	UL 1977
15	1F4,2F2,2F3,2F4	216002P/F2.0A 250V 5X20CFUSED	UL 248
14	2F5	ABB s20u ksa-1p UL HIGH BREAKER MINI CURRENT CIRCUIT	UL 489
13	2F1	ABB s20u k1a-1p UL HIGH BREAKER MINI CURRENT CIRCUIT	UL 489
12	1F3	ABB s20u ksa-1p UL HIGH BREAKER MINI CURRENT CIRCUIT	UL 489
11	1F2	ABB s20u ksa-1p UL HIGH BREAKER MINI CURRENT CIRCUIT	UL 489
10	1F1,2F6	216315P/F315A 250V 5X20CFUSED	UL 248
09	1U2	DEESEA7320 MKII MODUEL	UL 508
08	1U1	BATTERY CHARGE AC230V/DC12V	UL 1236
07	1L1	CANDPY LIGHT PD771WRR DC12V	
06	1S7	LDW WATER LEVEL SWITCH	
05	1S6	FEXIBLE SENSDR	
04	1S2	EMERGENCY STOP ABB UL	UL 94
03	1S1	CANDPY LIGHT SWITCH	
02	1RS,3R1	ROCKWELL 700-HHF6R212 UL DC12V 25A	UL 508
01	1R1,1R9,1R9,1R10	DRM270012LTKRELAYAND RELAY NC CONTACTOR	UL 508

ITEM	PART NO.	ITEM DESCRIPTION	UL REQUIREMENT	4	3	2	1
					X		
		PE(16AWG Y/G)		01	PE	0	PE
		PE(16AWG Y/G)		02	PE	0	PE
		PE(16AWG Y/G)		03	PE	0	PE
		60(16AWG BLACK)		04	60	0	60
		2(16AWG BLACK)		05	2	0	2
		2(16AWG BLACK)		06	2	0	2
		03(16AWG BLACK)		07	03	0	03
		3(16AWG BLACK)		08	3	0	3
		05(16AWG BLACK)		09	051	0	051
		5(16AWG BLACK)		10	51	0	51
		80(14AWG BLACK)		11	80	0	80
		N(80)(14AWG BLUE)		12	N(80)	0	N(80)
		N(80)(14AWG BLUE)		13	N(80)	0	N(80)
		8(14AWG BLACK)		14	81	0	81
		N(81)(14AWG BLUE)		15	N(81)	0	N(81)
		82(14AWG BLACK)		16	82	0	82
		N(82)(14AWG BLUE)		17	N(82)	0	N(82)
		83(14AWG BLACK)		18	83	0	83
		N(83)(14AWG BLUE)		19	N(83)	0	N(83)
		84(14AWG BLACK)		20	84	0	84
		N(84)(14AWG BLUE)		21	N(84)	0	N(84)
		85(14AWG BLACK)		22	85	0	85
		N(85)(14AWG BLUE)		23	N(85)	0	N(85)
		86(14AWG BLACK)		24	86	0	86
		10(16AWG BLACK)		25	10	0	10
		94(16AWG BLACK)		26	94	0	94
		95(16AWG BLACK)		27	95	0	95
		96(16AWG BLACK)		28	96	0	96
		97(16AWG BLACK)		29	97	0	97
		98(16AWG BLACK)		30	98	0	98
		99(16AWG BLACK)		31	99	0	99

⚠: Canopy Gen-set do not install emergency stop 1S2 button in start panel. 1S21 is optional emergency stop.
 ⚠: For all Aksa USA UL gensets are using two wire start off of digital input 48 to start the genset up.
 ⚠: 1~6#Terminal model: Weidmuller ZDU 2.5/4AN UL(U.L1059). 7~31#Terminal model: Weidmuller ZDU2.5 UL(U.L1059).

ORDER CODE:	SCALE: 1:1	MATERIAL:	QUANTITY:	WEIGHT:

2015	DATE	NAME	SIGNATURE
DRAWING BY 10.25	CAOKUN		
CONTROL BY 10.25	TOM		
APPROVED BY 10.25	TOTO		
DEPARTMENT: ENGINEERING			

ORDER CODE:	SCALE: 1:1	MATERIAL:	QUANTITY:	WEIGHT:
PART NO.:	APD-ULP65/82/100(PERKINS 1104D-E44 DSE7320)	LOCATION:	A4	PAGE 4-4
DRAWING NO.:	SP.P2362082 UL			
REVISION NO.:	00			



AKSA POWER GENERATION
 ONLY ENGINEERING DEPT. OF AKSA CORP. HAS RIGHT TO KEEP AND MODIFY IT.
 IT CAN NOT BE SPUN OFF OR GIVED TO THE 3TH ORGANIZATION.

APD-ULV250 - 600

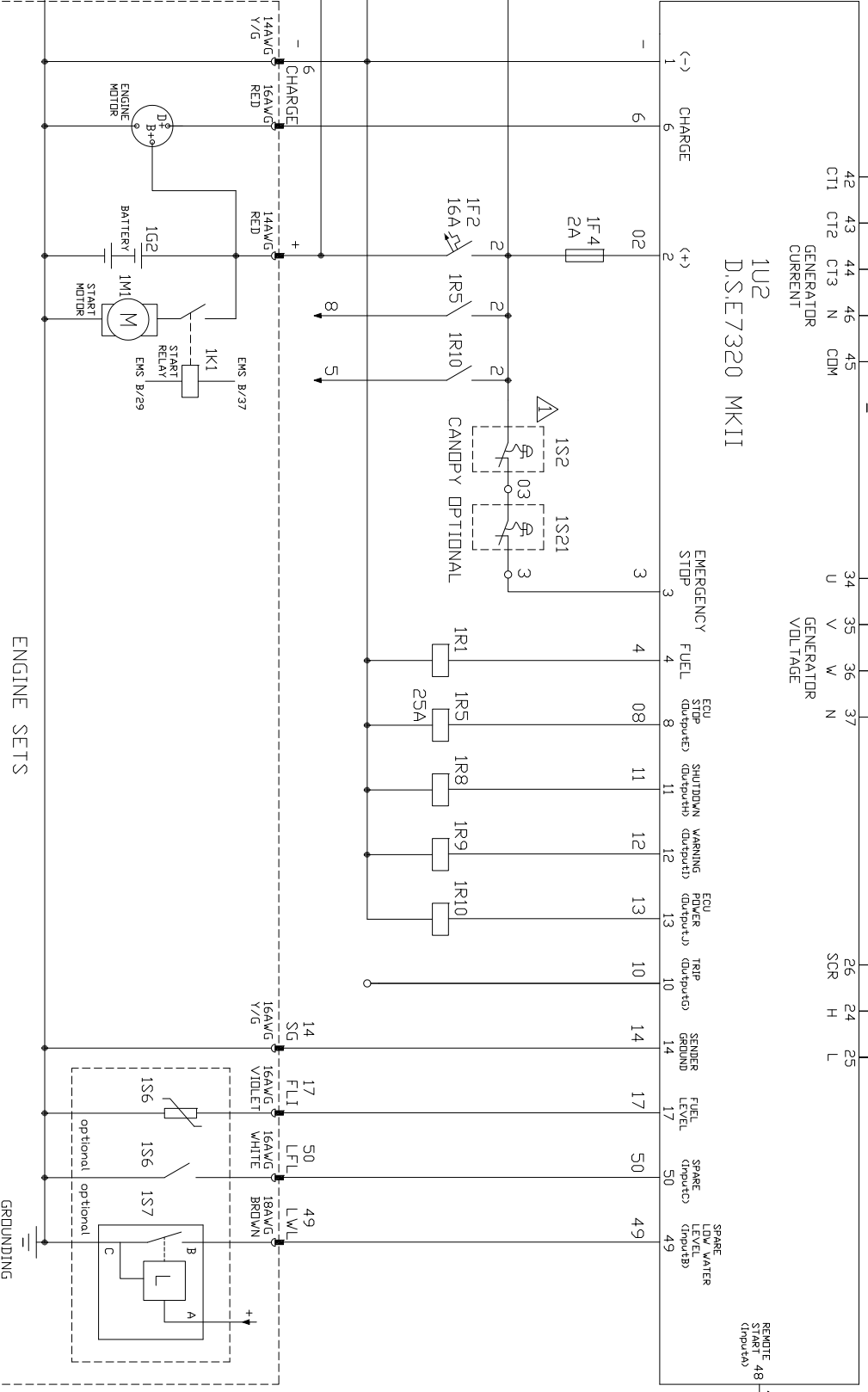
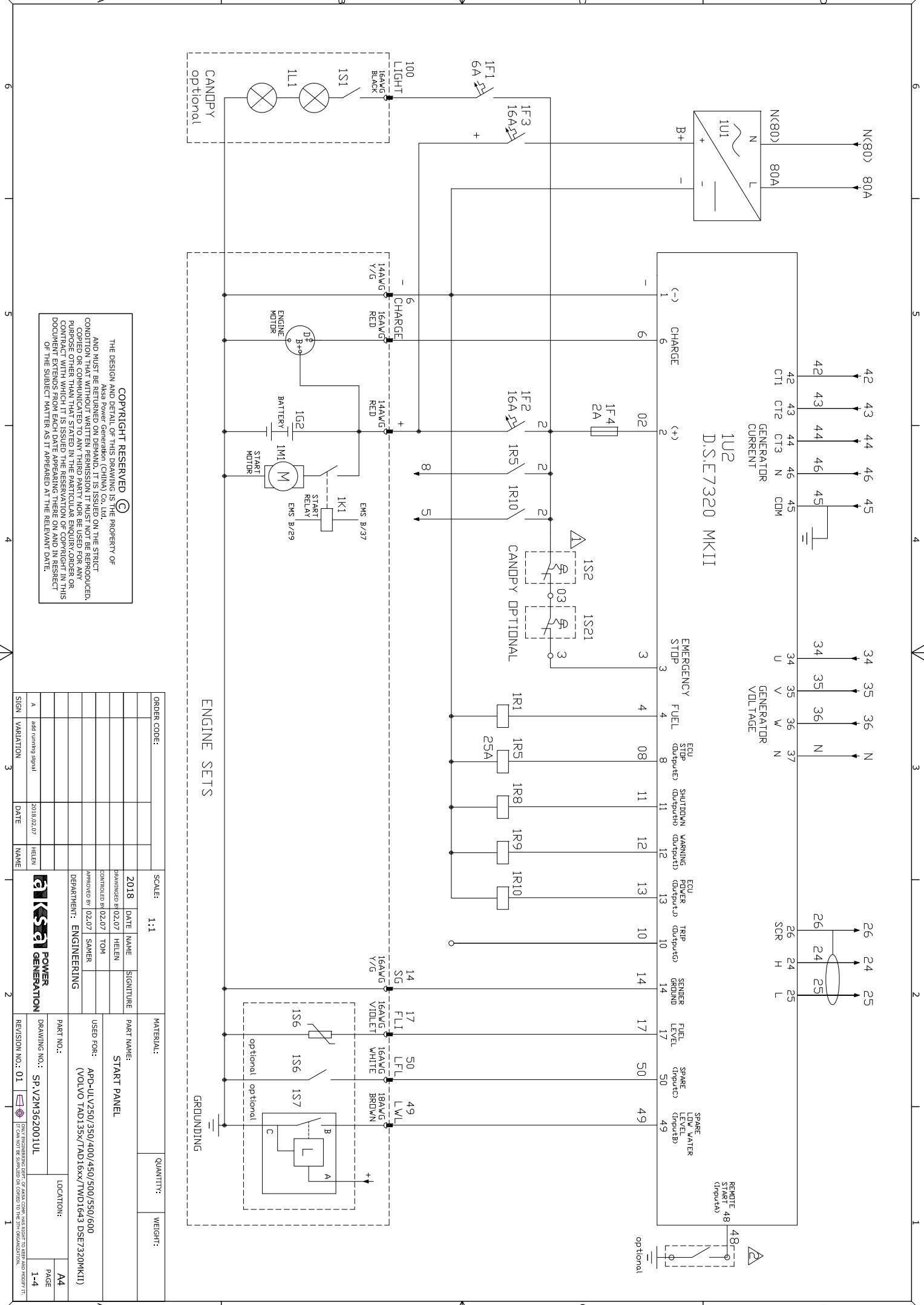

ENGINE SETS

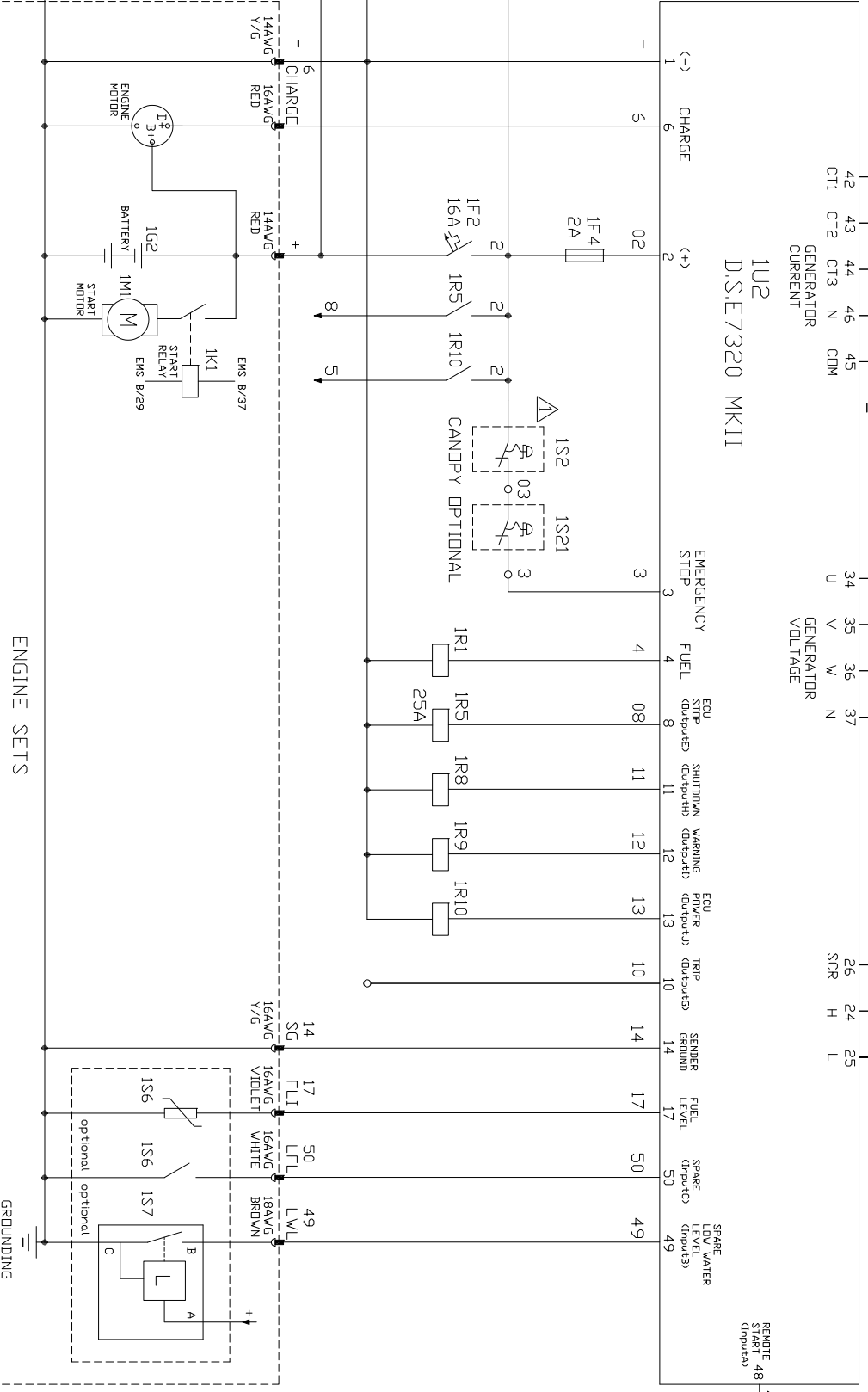

ENGINE SETS

COPYRIGHT RESERVED
 AKSA Power Generation (CHINA) Co., Ltd.
 AND MUST BE RETURNED ON DEMAND. IT IS ISSUED ON THE STRICT
 CONFIDENCE OF THE DRAWING AND IS NOT TO BE REPRODUCED,
 COPIED OR COMMUNICATED TO ANY THIRD PARTY. NOT BE USED FOR ANY
 PURPOSE OTHER THAN THAT STATED IN THE PARTICULAR ENQUIRY, ORDER OR
 CONTRACT WITH WHICH IT IS ISSUED. THE RESERVATION OF COPYRIGHT IN THIS
 DOCUMENT EXTENDS FROM EACH DATE APPEARING THERE ON AND IN RESPECT
 OF THE SUBJECT MATTER AS IT APPEARED AT THE RELEVANT DATE.

ORDER CODE:	SCALE: 1:1	MATERIAL:	QUANTITY:	WEIGHT:
2018	DATE	NAME	SIGNATURE	
DESIGNED BY	HELEN			
CONTROLLED BY	02.07	TONI		
APPROVED BY	02.07	SAMER		
DEPARTMENT: ENGINEERING				
PART NO.:	USED FOR:			
SP.V2M362001UL	APP-UJ/250/350/400/450/500/550/600			
	(VOLVO TAD135X/TAD163X/TWD1643 DSE7320MK11)			
REVISION NO.: 01	DRAWING NO.:	LOCATION:	PAGE	
	SP.V2M362001UL		A4	
			1-4	

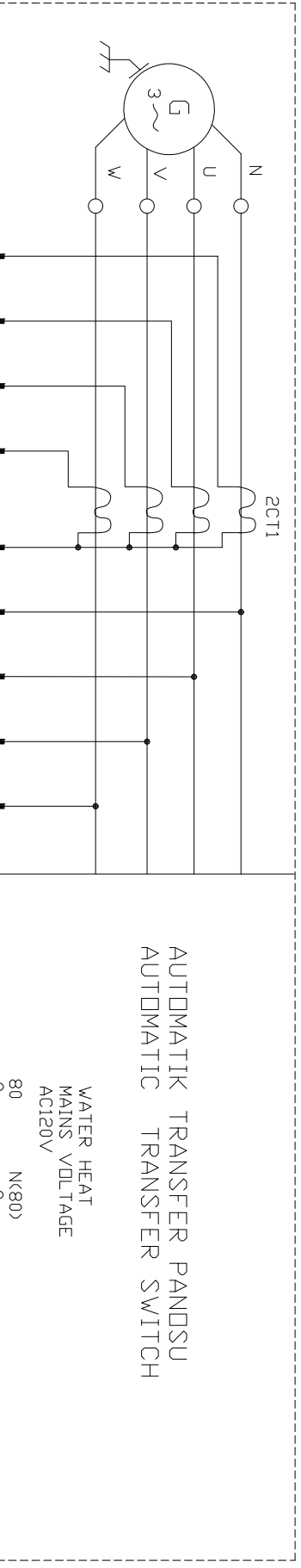

**AUTOMATIK TRANSFER PANSU
AUTOMATIC TRANSFER SWITCH**

WATER HEAT
MAINS VOLTAGE
AC120V

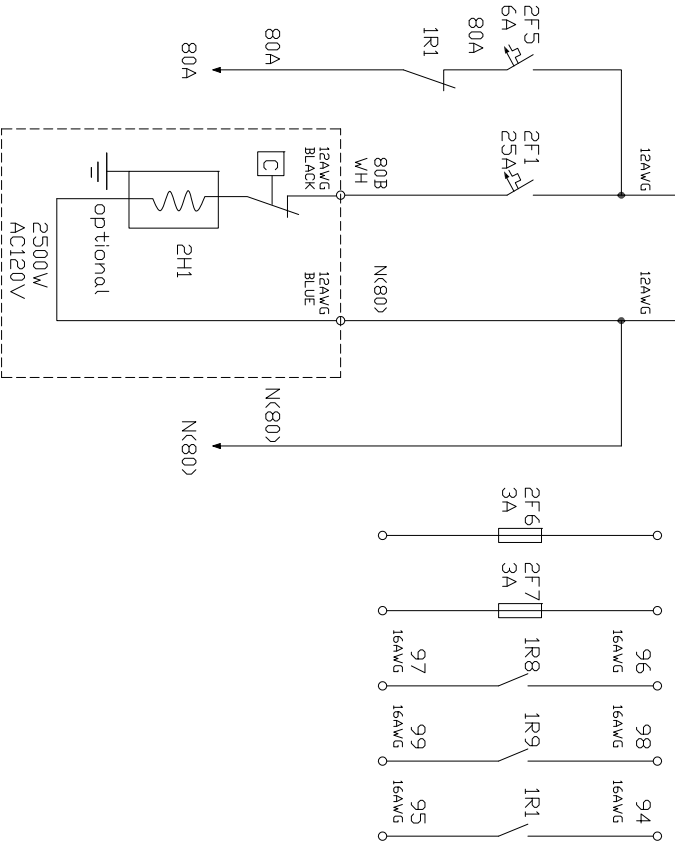
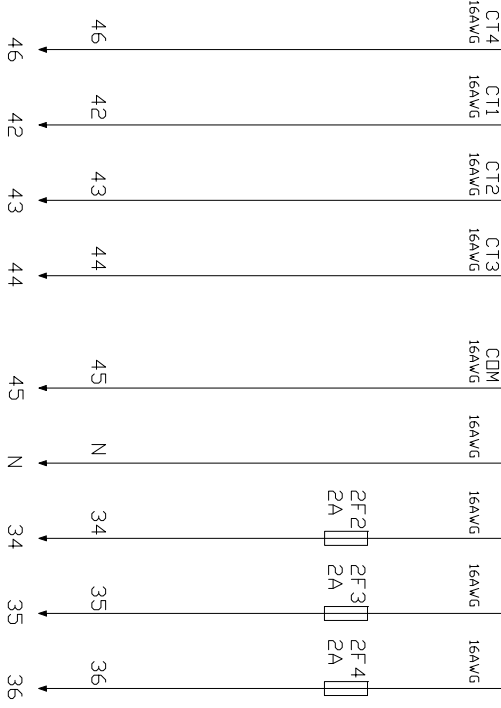
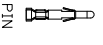
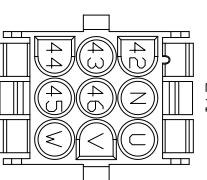
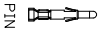
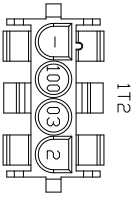
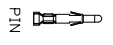
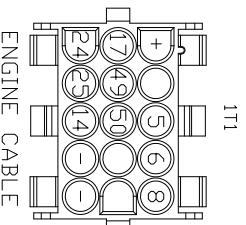

COPYRIGHT RESERVED

THE DESIGN AND DETAIL OF THIS DRAWING IS THE PROPERTY OF
Ases Power Generation (China) Co., Ltd.
 AND MUST BE KEPT IN STRICT CONFIDENTIALITY. ANY REPRODUCTION,
 COPIED OR COMMUNICATED TO ANY THIRD PARTY NOR BE USED FOR ANY
 PURPOSE OTHER THAN THAT STATED IN THE PARTICULAR ENQUIRY, ORDER OR
 CONTRACT WITH WHICH IT IS ISSUED. THE RESERVATION OF COPYRIGHT IN THIS
 DOCUMENT EXTENDS FROM EACH DATE APPEARING THERE ON AND IN RESPECT
 OF THE SUBJECT MATTER AS IT APPEARED AT THE RELEVANT DATE.

ORDER CODE:	SCALE: 1:1	MATERIAL:	QUANTITY:	WEIGHT:
2018	DATE	NAME	SIGNATURE	
DRAWING BY 02.07	HELEN			
CONTROL BY 02.07	TOM			
APPROVED BY 02.07	SAMER			
DEPARTMENT:	ENGINEERING			
PART NO.:	APP-ULV250/350/400/450/500/550/600 (VOLVO TAD135X/TAD16xx/TWD1643 DSE7320MK11)			
DRAWING NO.:	SP-V2M362001UL			
REVISION NO.:	01	LOCATION:		
			PAGE	A4
			2-4	

VOLVO ECM (ENGINE CONTROL MODULE EMS 8Pin)

J1939

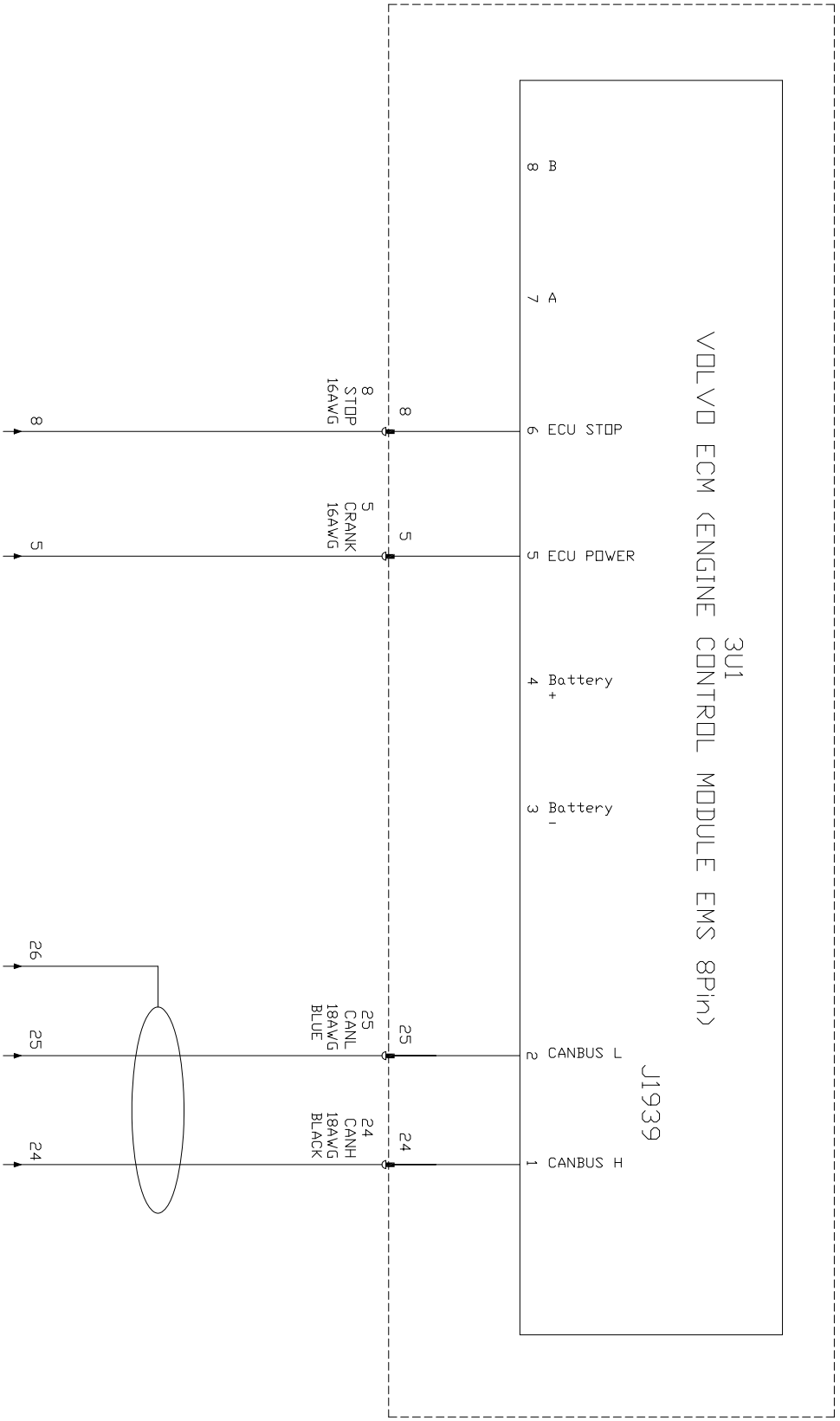

COPYRIGHT RESERVED ©
 THE DESIGN AND DETAIL OF THIS DRAWING IS THE PROPERTY OF
 AASA POWER GENERATION (CHINA) CO., LTD.
 AND MUST BE KEPT CONFIDENTIAL. IT IS NOT TO BE REPRODUCED,
 COPIED OR COMMUNICATED TO ANY THIRD PARTY NOR BE USED FOR ANY
 PURPOSE OTHER THAN THAT STATED IN THE PARTICULAR ENQUIRY, ORDER OR
 CONTRACT WITH WHICH IT IS ISSUED. THE RESERVATION OF COPYRIGHT IN THIS
 DOCUMENT EXTENDS FROM EACH DATE APPEARING THERE ON AND IN RESPECT
 OF THE SUBJECT MATTER AS IT APPEARED AT THE RELEVANT DATE.

ORDER CODE:	SCALE: 1:1	MATERIAL:	QUANTITY:	WEIGHT:
	2018	DATE	NAME	SIGNATURE
	DRAWING BY: 02.07	HELEN		
	CONTROL BY: 02.07	TOM		
	APPROVED BY: 02.07	SAMER		
	DEPARTMENT:	ENGINEERING		
PART NO.:	PART NAME:	START PANEL		
DRAWING NO.:	USED FOR:	APP-U/LV250/350/400/450/500/550/600 (VOLVO TAD135X/TAD16xx/TWD1643 DSE7320MK11)		
REVISION NO.: 01	PART NO.:	SP-V2M362001UL	LOCATION:	A4
				PAGE 3-4



ONLY ENGINEERING DEPT. OF AASA CORP. HAS RIGHT TO KEEP AND MODIFY IT.
 IT CAN NOT BE SAMPLED OR COPIED TO THE 3RD ORGANIZATION.

80B(12AWG BLACK)		X		
80B	0 01	80B	0	
NK80(12AWG BLUE)	0 02	NK80	0	
				80B
				NK80

WATER HEATER

COPYRIGHT RESERVED
 THE DESIGN AND DETAIL OF THIS DRAWING IS THE PROPERTY OF
 AND MUST BE RETURNED ON DEMAND. IT IS ISSUED ON THE STRICT
 CONDITION THAT WITHOUT WRITTEN PERMISSION IT MUST NOT BE REPRODUCED,
 COPIED OR COMMUNICATED TO ANY THIRD PARTY NOR BE USED FOR ANY
 PURPOSE OTHER THAN THAT STATED IN THE PARTICULAR ENQUIRY, ORDER OR
 CONTRACT WITH WHICH IT IS ISSUED. THIS DRAWING IS COPYRIGHTED IN THIS
 DOCUMENT BY THE DESIGNER AND HIS EMPLOYERS. ANY REPRODUCTION OR
 OF THE SUBJECT MATTER AS IT APPEARED AT THE RELEVANT DATE.

21	2H1	WATER HEATER UL	UL Approved
20	2CT1	CURRENT TRANSFORMER UL	UL Approved
19	2T1	TYCD 9HOLE 1-480707-0	UL 1977
18	1T2	TYCD 4HOLE 1-480703-0	UL 1977
17	1T1	TYCD 15HOLE 1-480711-0	UL 1977

16	1F4,2F2,2F3,2F4	216002P/F20A 250V 5x20(FUSE)	UL 248
15	2F5	ABB 250U K5A-1PKIGH BREAKER MINI CURRENT CIRCUIT	UL 489
14	2F1	ABB 250U K5A-1PKIGH BREAKER MINI CURRENT CIRCUIT	UL 489
13	1F3	ABB 250U K5A-1PKIGH BREAKER MINI CURRENT CIRCUIT	UL 489
12	1F2	ABB 250U K5A-1PKIGH BREAKER MINI CURRENT CIRCUIT	UL 489
11	1F1	ABB 250U K5A-1PKIGH BREAKER MINI CURRENT CIRCUIT	UL 489
10	2F6,2F7	216315P/F315A 250V 5x20(FUSE)	UL 248
09	1U2	DEEPSEA7320 MKII MODULE	UL 508
08	1U1	BATTERY CHARGE DSE9470 MKII DC24V 10A	UL 1236
07	1L1	CANDPY LIGHT PD771WRR DC12V	
06	1S7	LDW WATER LEVEL SWITCH	
05	1S6	FEXIBLE SENSOR	
04	1S2	EMERGENCY STOP ABB UL	UL 94
03	1S1	CANDPY LIGHT SWITCH	
02	1RS	RICKWELL 700-HHF62224/SCHIEDER 389F1XBXC-24D DC24V 25A	UL 508
01	1R5,1R8,1R10	DRM270024L(T)RELAYAND RELAY NC CONTACTOR	UL 508

PE(16AWG Y/G)	0	01	PE	0	0	PE
PE(16AWG Y/G)	0	02	PE	0	0	PE
PE(16AWG Y/G)	0	03	PE	0	0	PE
48(16AWG BLACK)	0	04	48	0	0	48
2(16AWG BLACK)	0	05	2	0	0	2
2(16AWG BLACK)	0	06	2	0	0	2
03(16AWG BLACK)	0	07	03	0	0	03
3(16AWG BLACK)	0	08	3	0	0	3
80(12AWG BLACK)	0	09	80	0	0	80
NK80(12AWG BLUE)	0	10	NK80	0	0	NK80
NK80(12AWG BLUE)	0	11	NK80	0	0	NK80
81(14AWG BLACK)	0	12	81	0	0	81
NK81(14AWG BLUE)	0	13	NK81	0	0	NK81
82(14AWG BLACK)	0	14	82	0	0	82
NK82(14AWG BLUE)	0	15	NK82	0	0	NK82
83(14AWG BLACK)	0	16	83	0	0	83
NK83(14AWG BLUE)	0	17	NK83	0	0	NK83
84(14AWG BLACK)	0	18	84	0	0	84
NK84(14AWG BLUE)	0	19	NK84	0	0	NK84
85(14AWG BLACK)	0	20	85	0	0	85
NK85(14AWG BLUE)	0	21	NK85	0	0	NK85
86(14AWG BLACK)	0	22	86	0	0	86
10(16AWG BLACK)	0	23	10	0	0	10
94(16AWG BLACK)	0	24	94	0	0	94
95(16AWG BLACK)	0	25	95	0	0	95
96(16AWG BLACK)	0	26	96	0	0	96
97(16AWG BLACK)	0	27	97	0	0	97
98(16AWG BLACK)	0	28	98	0	0	98
99(16AWG BLACK)	0	29	99	0	0	99

⚠ Canopy Gen-set do not install emergency stop 1S2 button in start panel. 1S21 is optional emergency stop.
 ⚠ For all Aksa USA UL gensets are using two wire start off of digital input 48 to start the genset up.
 ⚠ 1-6# Terminal model: Weidmuller ZDU 25/44N UL(UL1059), 7,8,12-29# Terminal model: Weidmuller ZDU25 UL(UL1059),
 9~11,01~02# Terminal model: Weidmuller ZDU4 UL(UL1059).

ORDER CODE:	SCALE: 1:1	MATERIAL:	QUANTITY:	WEIGHT:
2018	DATE: 02.07	NAME: HELEN	SIGNATURE:	
DESIGNED BY: TOM	CONTROLLED BY: 02.07	APPROVED BY: 02.07	SAMER	
DEPARTMENT: ENGINEERING				
USED FOR: APP-ULV250/350/400/450/500/550/600				
(VOLVO TAD135X/TAD165X/TWD1643 DSE7320MK11)				
PART NO.: SP-V2M362001UL				
DRAWING NO.: SP-V2M362001UL				
REVISION NO.: 01				
LOCATION: A4				
PAGE 4-4				

APD-ULM800

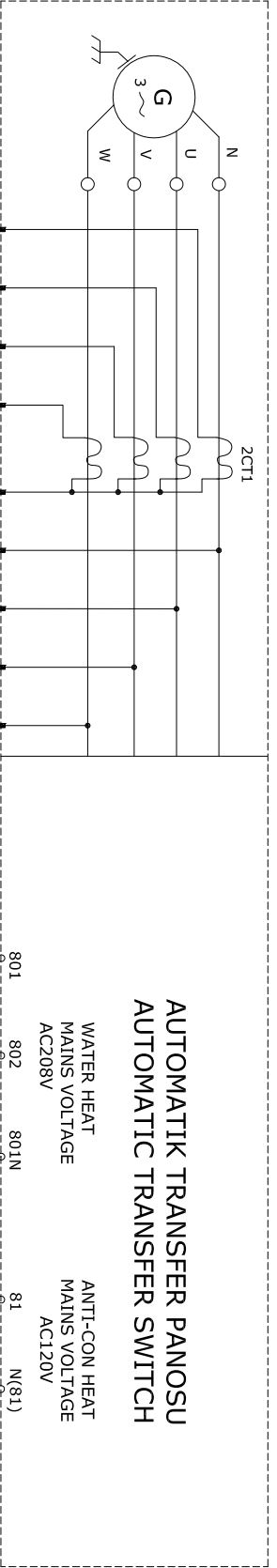

**AUTOMATIK TRANSFER PANOSU
AUTOMATIC TRANSFER SWITCH**

WATER HEAT
MAINS VOLTAGE
AC208V

ANTI-CON HEAT
MAINS VOLTAGE
AC120V

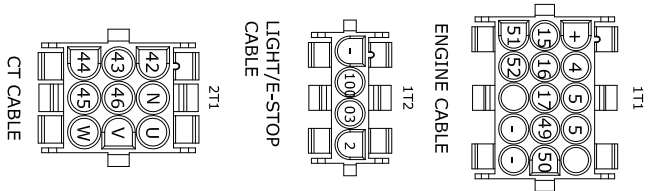

COPYRIGHT RESERVED ©

THE DESIGN AND DETAIL OF THIS DRAWING IS THE PROPERTY OF
KESAL POWER GENERATION AND MUST BE RETURNED ON DEMAND. IT IS ISSUED ON THE STRICT
CONDITION THAT WITHOUT WRITTEN PERMISSION IT MUST NOT BE REPRODUCED,
COPIED OR COMMUNICATED TO ANY THIRD PARTY NOR BE USED FOR ANY
PURPOSE OTHER THAN THAT STATED IN THE PARTICULAR ENQUIRY, ORDER OR
CONTRACT WITH WHICH IT IS ISSUED. THE RESERVATION OF COPYRIGHT IN THIS
DOCUMENT EXTENDS FROM EACH DATE APPEARING THERE ON AND IN RESPECT
OF THE SUBJECT MATTER AS IT APPEARED AT THE RELEVANT DATE.

ORDER CODE:	SCALE: 1:1	MATERIAL:	QUANTITY:	WEIGHT:
	2017	DATE	SIGNATURE	PART NAME:
		12/204	Jydhahband	START PANEL
		12/204	HELEN	DESIGNED BY:
		12/204	TON	CONTROLLED BY:
				DEPARTMENT: ENGINEERING
				USED FOR: APD-UJ-M800(WT)SUBSISHI S12A2 DSE720MKII WITH ANTI-CON/VOLTAGE ADJUST 480/277V/NO BATTERY CHARGER
				PART NO.:
				DRAWING NO.: SP-M2364853 UL
				REVISION NO.: 00
				LOCATION:
				PAGE 2-4



THIS DOCUMENT IS THE PROPERTY OF KESAL POWER GENERATION. IT IS ISSUED ON THE STRICT CONDITION THAT WITHOUT WRITTEN PERMISSION IT MUST NOT BE REPRODUCED, COPIED OR COMMUNICATED TO ANY THIRD PARTY NOR BE USED FOR ANY PURPOSE OTHER THAN THAT STATED IN THE PARTICULAR ENQUIRY, ORDER OR CONTRACT WITH WHICH IT IS ISSUED. THE RESERVATION OF COPYRIGHT IN THIS DOCUMENT EXTENDS FROM EACH DATE APPEARING THERE ON AND IN RESPECT OF THE SUBJECT MATTER AS IT APPEARED AT THE RELEVANT DATE.

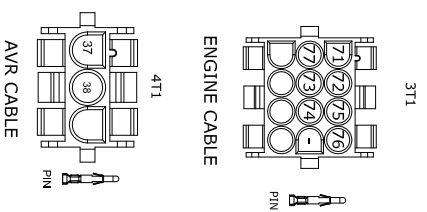
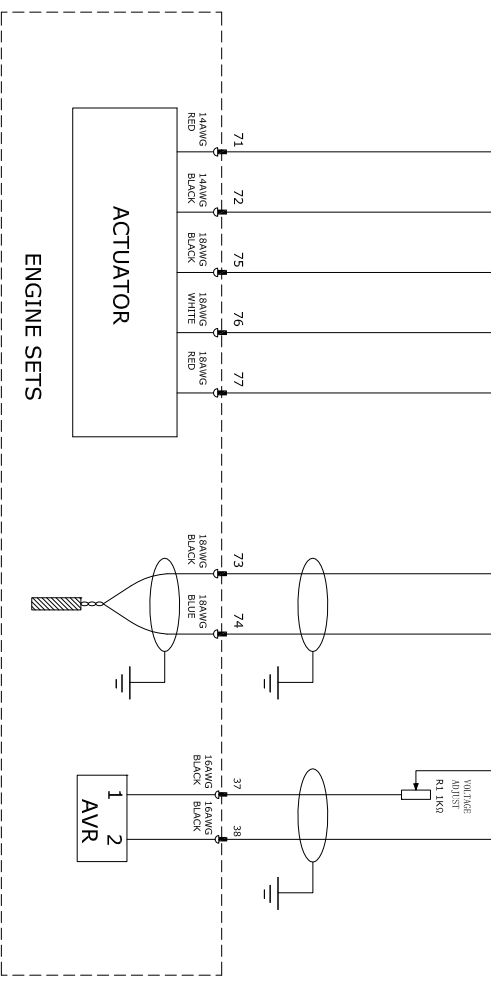
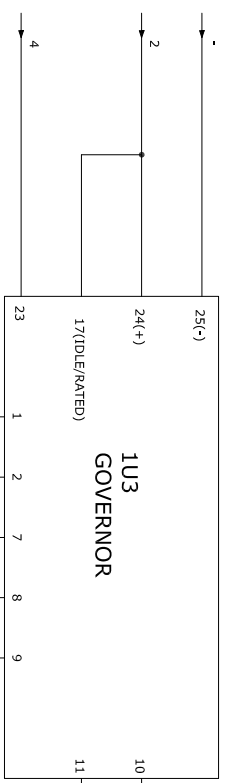

COPYRIGHT RESERVED ©

THE DESIGN AND DETAIL OF THIS DRAWING IS THE PROPERTY OF
 AND MUST BE RETURNED ON DEMAND. IT IS ISSUED ON THE STRICT
 CONDITION THAT WITHOUT WRITTEN PERMISSION IT MUST NOT BE REPRODUCED,
 COPIED OR COMMUNICATED TO ANY THIRD PARTY NOR BE USED FOR ANY
 PURPOSE OTHER THAN THAT STATED IN THE PARTICULAR ENQUIRY, ORDER OR
 CONTRACT WITH WHICH IT IS ISSUED. THE RESERVATION OF COPYRIGHT IN THIS
 DOCUMENT EXTENDS FROM EACH DATE APPEARING THERE ON AND IN RESPECT
 OF THE SUBJECT MATTERS AS IT APPEARED AT THE RELEVANT DATE.

ORDER CODE:	SCALE: 1:1	MATERIAL:	QUANTITY:	WEIGHT:
	2017	DATE	NAME	SIGNATURE
	12/04	12/04	HELEN	
	12/04	TOM		
	DEPARTMENT: ENGINEERING			
	USED FOR: ARP-UJ-M800/MTSUBISHI S12A2 DSE7320MKII WITH ANTI-CONVOLTAGE ADJUST 480/277V/NO BATTERY CHARGER			
	PART NO.: SP-M2364853 UL			
	DRAWING NO.: 00			
	REVISION NO.: 00			
	LOCATION:			
	PAGE 3-4			

2017 12/04 12/04 HELEN

12/04 TOM

DEPARTMENT: ENGINEERING

USED FOR: ARP-UJ-M800/MTSUBISHI S12A2 DSE7320MKII WITH ANTI-CONVOLTAGE ADJUST 480/277V/NO BATTERY CHARGER

PART NO.: SP-M2364853 UL

DRAWING NO.: 00

REVISION NO.: 00

LOCATION:

PAGE 3-4



ORDER CODE: _____

SCALE: 1:1

MATERIAL: _____

QUANTITY: _____

WEIGHT: _____

DATE: 2017

NAME: HELEN

SIGNATURE: _____

DATE: 12/04

NAME: TOM

SIGNATURE: _____

DEPARTMENT: ENGINEERING

USED FOR: ARP-UJ-M800/MTSUBISHI S12A2 DSE7320MKII WITH ANTI-CONVOLTAGE ADJUST 480/277V/NO BATTERY CHARGER

PART NO.: SP-M2364853 UL

DRAWING NO.: 00

REVISION NO.: 00

LOCATION: _____

PAGE 3-4

2017 12/04 12/04 HELEN

12/04 TOM

DEPARTMENT: ENGINEERING

USED FOR: ARP-UJ-M800/MTSUBISHI S12A2 DSE7320MKII WITH ANTI-CONVOLTAGE ADJUST 480/277V/NO BATTERY CHARGER

PART NO.: SP-M2364853 UL

DRAWING NO.: 00

REVISION NO.: 00

LOCATION:

PAGE 3-4



ORDER CODE: _____

SCALE: 1:1

MATERIAL: _____

QUANTITY: _____

WEIGHT: _____

DATE: 2017

NAME: HELEN

SIGNATURE: _____

DATE: 12/04

NAME: TOM

SIGNATURE: _____

DEPARTMENT: ENGINEERING

USED FOR: ARP-UJ-M800/MTSUBISHI S12A2 DSE7320MKII WITH ANTI-CONVOLTAGE ADJUST 480/277V/NO BATTERY CHARGER

PART NO.: SP-M2364853 UL

DRAWING NO.: 00

REVISION NO.: 00

LOCATION: _____

PAGE 3-4

THE DESIGN AND DETAIL OF THIS DRAWING IS THE PROPERTY OF AND MUST BE RETURNED ON DEMAND. IT IS ISSUED ON THE STRICT CONDITION THAT WITHOUT WRITTEN PERMISSION IT MUST NOT BE REPRODUCED, COPIED, EITHER WHOLLY OR IN PART, OR TRANSMITTED IN ANY FORM OR BY ANY MEANS, ELECTRONIC OR MECHANICAL, INCLUDING PHOTOCOPYING, RECORDING, OR BY ANY INFORMATION STORAGE AND RETRIEVAL SYSTEM. WITHOUT THE WRITTEN PERMISSION OF THE DESIGNER, NO PART OF THIS DRAWING IS TO BE REPRODUCED OR TRANSMITTED IN ANY FORM OR BY ANY MEANS, ELECTRONIC OR MECHANICAL, INCLUDING PHOTOCOPYING, RECORDING, OR BY ANY INFORMATION STORAGE AND RETRIEVAL SYSTEM. WITHOUT THE WRITTEN PERMISSION OF THE DESIGNER, NO PART OF THIS DRAWING IS TO BE REPRODUCED OR TRANSMITTED IN ANY FORM OR BY ANY MEANS, ELECTRONIC OR MECHANICAL, INCLUDING PHOTOCOPYING, RECORDING, OR BY ANY INFORMATION STORAGE AND RETRIEVAL SYSTEM. WITHOUT THE WRITTEN PERMISSION OF THE DESIGNER, NO PART OF THIS DRAWING IS TO BE REPRODUCED OR TRANSMITTED IN ANY FORM OR BY ANY MEANS, ELECTRONIC OR MECHANICAL, INCLUDING PHOTOCOPYING, RECORDING, OR BY ANY INFORMATION STORAGE AND RETRIEVAL SYSTEM.

ITEM	PART NO.	ITEM DESCRIPTION	UL REQUIREMENT
27	R1	RESISTANCE 1KΩ 10 TURNS	
26	2H1	WATER HEATER UL	
25	2CT1	CURRENT TRANSFORMER UL	UL Approved (ANSI/IEEE C37.13)
24	4T1	TYCO 3HOLE 1-480709-0	UL 1977
23	3T1	TYCO 12HOLE 1-480709-0	UL 1977
22	2T2	TYCO 6HOLE 1-480707-0	UL 1977
21	2T1	TYCO 9HOLE 1-480707-0	UL 1977
20	1T2	TYCO 4HOLE 1-480703-0	UL 1977
19	1T1	TYCO 15HOLE 1-480711-0	UL 1977
18	1F4, 2F2, 2F3, 2F4	216002P/F2.0A 250V 5X20(FUSE)	UL 248
17	2F5, 2F8	ABB S201U K6A-1P(HIGH BREAKER MINI CURRENT CIRCUIT)	UL 489
16	2F1	ABB S202P K32A-2P(HIGH BREAKER MINI CURRENT CIRCUIT)	UL 489
15	1F3	ABB S201U K16A-1P(HIGH BREAKER MINI CURRENT CIRCUIT)	UL 489
14	1F2	ABB S201U K32A-1P(HIGH BREAKER MINI CURRENT CIRCUIT)	UL 489
13	1F1	ABB S201U K10A-1P(HIGH BREAKER MINI CURRENT CIRCUIT)	UL 489
12	2F6, 2F7	2163.15P/F3.15A 250V 5X20(FUSE)	UL 248
11	1U2	DEEPESEA7320 MKII MODULE	UL 508
10	1U1	BATTERY CHARGE AC230V/DC24V	UL 1236
09	1L1	CANOPY LIGHT PD771WRB DC12V	
08	1S7	LOW WATER LEVEL SWITCH	
07	1S6	FLEXIBLE SENSOR	
06	1S5	WATER TEMP. SENSOR	
05	1S4	OIL PRESS SENSOR	
04	1S2	EMERGENCY STOP ABB UL	UL 94
03	1S1	CANOPY LIGHT SWITCH	
02	1R1, 1R2	ROCKWELL 700-HHF6Z224/SCHNEIDER 389F8XC1-24D DC24V 25A	UL 508
01	1R8, 1R9, 1R11	DRM270024LT(RELAY)AND RELAY N.C CONTRACTOR	UL 508

Terminal	Wire	Color	Function
PE(16AWG Y/G)	0 1	PE	PE
PE(16AWG Y/G)	0 2	PE	PE
PE(16AWG Y/G)	0 3	PE	PE
48(16AWG BLACK)	0 4	48	48
2(16AWG BLACK)	0 5	2	2
2(16AWG BLACK)	0 6	2	2
33(16AWG BLACK)	0 7	33	33
03(16AWG BLACK)	0 8	03	03
3(16AWG BLACK)	0 9	3	3
801N(14AWG BLUE)	0 10	801N	801N
801(10AWG BLACK)	0 11	801	801
802(10AWG BLACK)	0 12	802	802
81(14AWG BLACK)	0 13	81	81
N(81)(14AWG BLUE)	0 14	N(81)	N(81)
82(14AWG BLACK)	0 15	82	82
N(82)(14AWG BLUE)	0 16	N(82)	N(82)
83(14AWG BLACK)	0 17	83	83
N(83)(14AWG BLUE)	0 18	N(83)	N(83)
84(14AWG BLACK)	0 19	84	84
N(84)(14AWG BLUE)	0 20	N(84)	N(84)
85(14AWG BLACK)	0 21	85	85
N(85)(14AWG BLUE)	0 22	N(85)	N(85)
86(14AWG BLACK)	0 23	86	86
10(16AWG BLACK)	0 24	10	10
94(16AWG BLACK)	0 25	94	94
95(16AWG BLACK)	0 26	95	95
96(16AWG BLACK)	0 27	96	96
97(16AWG BLACK)	0 28	97	97
98(16AWG BLACK)	0 29	98	98
99(16AWG BLACK)	0 30	99	99
801B(12AWG BLACK)	0 31	801B	801B
802(12AWG BLACK)	0 32	802	802

⚠ : Canopy Gen-set do not install emergency stop 1S2 button in start panel.1S21 is optional emergency stop.
 ⚠ : For all Aksa USA UL gensets are using two wire start off of digital Input48 to start the genset up.
 ⚠ : 1~6# Terminal model:Weldmuller ZDU 2.5/4AN UL(U11059).7~10,13~30# Terminal model:Weldmuller ZDU2.5 UL(U11059).
 ⚠ : 11~12# Terminal model:Weldmuller ZDU10 UL(U11059).31~32# Terminal model:Weldmuller ZDU4 UL(U11059).

ORDER CODE:	SCALE: 1:1	MATERIAL:	QUANTITY:	WEIGHT:
SIGN VARIATION	DATE	NAME		
	2017	DATE	NAME	SIGNATURE
	DESIGNED BY 12204	LDJ/qjshang		
	CHECKED BY 12204	HJLBN		
	APPROVED BY 12204	YOM		
	DEPARTMENT:	ENGINEERING		
	USED FOR:	START PANEL		
	ANTI-COV/VOLTAGE ADJUST 480/277V/NO BATTERY CHARGER			
	DRAWING NO.:	SF_M2364833 UL		
	REVISION NO.:	00		
	LOCATION:			
	PAGE	4-4		

APD-ULM1000

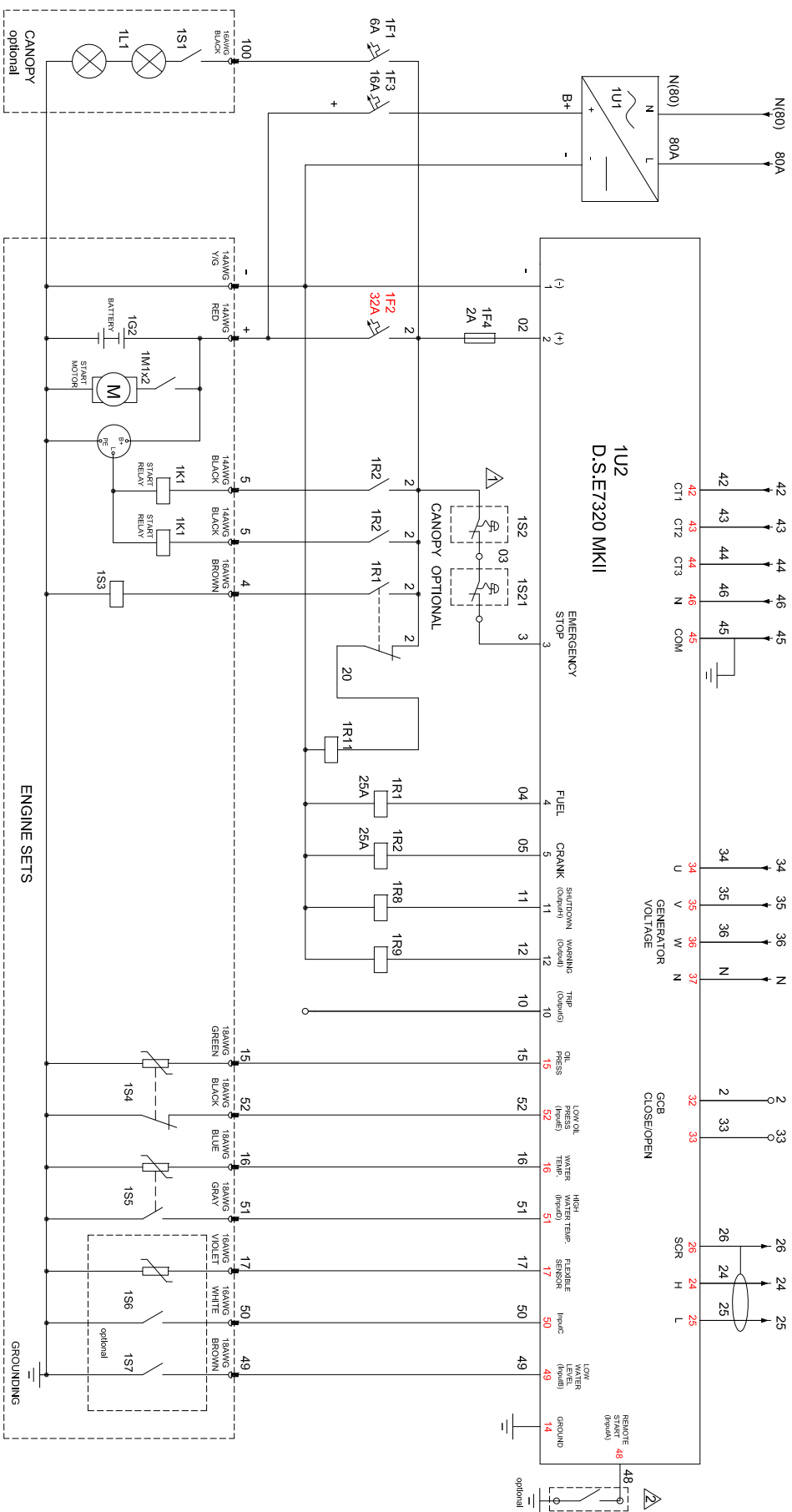

COPYRIGHT RESERVED

THE DESIGN AND DETAIL OF THIS DRAWING IS THE PROPERTY OF
 KESAI POWER GENERATION (PVT) LTD. (KESAI GENCO) AND
 MUST BE RETURNED ON DEMAND. IT IS ISSUED ON THE STRICT
 CONDITION THAT WITHOUT WRITTEN PERMISSION IT MUST NOT BE REPRODUCED,
 COPIED OR COMMUNICATED TO ANY THIRD PARTY NOR BE USED FOR ANY
 PURPOSE OTHER THAN THAT STATED IN THE PARTICULAR ENQUIRY, ORDER OR
 CONTRACT WITH WHICH IT IS ISSUED. THE RESERVATION OF COPYRIGHT IN THIS
 DOCUMENT EXTENDS FROM EACH DATE APPEARING THERE ON AND IN RESPECT
 OF THE SUBJECT MATTERS AS IT APPEARED AT THE RELEVANT DATE.

ORDER CODE:	SCALE:	1:1	MATERIAL:	QUANTITY:	WEIGHT:
	DATE:	2017	NAME:	START PANEL	
	DESIGNED BY:	HELEN	COMPILED BY:	TONI	
	APPROVED BY:	TOTO	DEPARTMENT:	ENGINEERING	
	USED FOR:	APP-DLM1000/MH/SH/SH1 SZ1H DSE/320M/KIT WITH AMT1-COM/9KW WATER HEATER)			
	PART NO.:	S-P-M2362084UL			
	DRAWING NO.:				
	REVISION NO.:	01	LOCATION:		
	SIGN:	HELEN	DATE:	2017.02.05	NAME:
	VARIATION:	3			

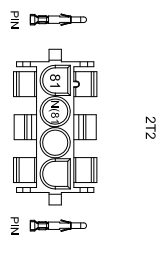
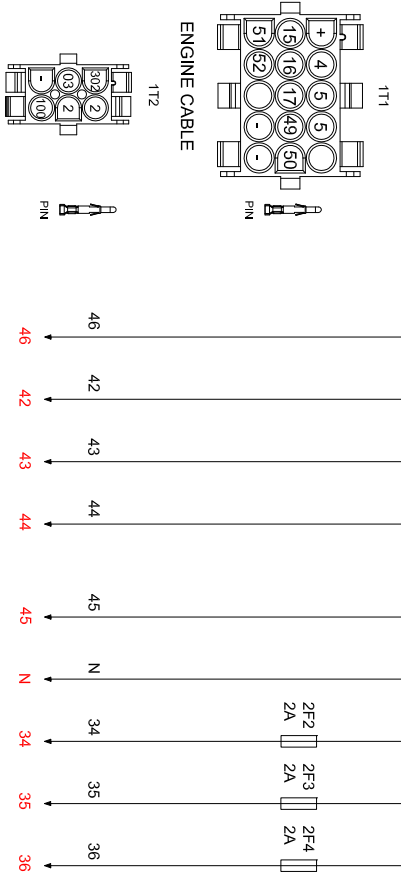
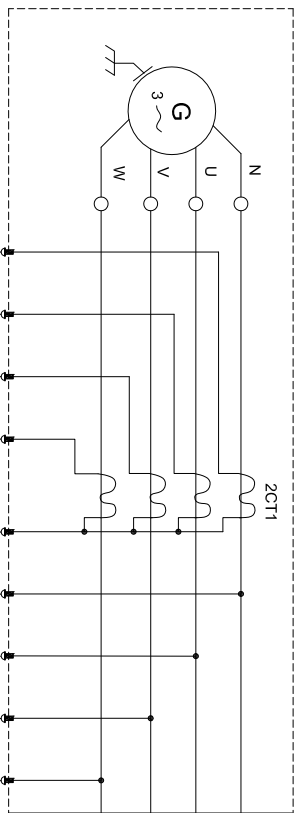

AUTOMATIK TRANSFER PANOSU AUTOMATIC TRANSFER SWITCH

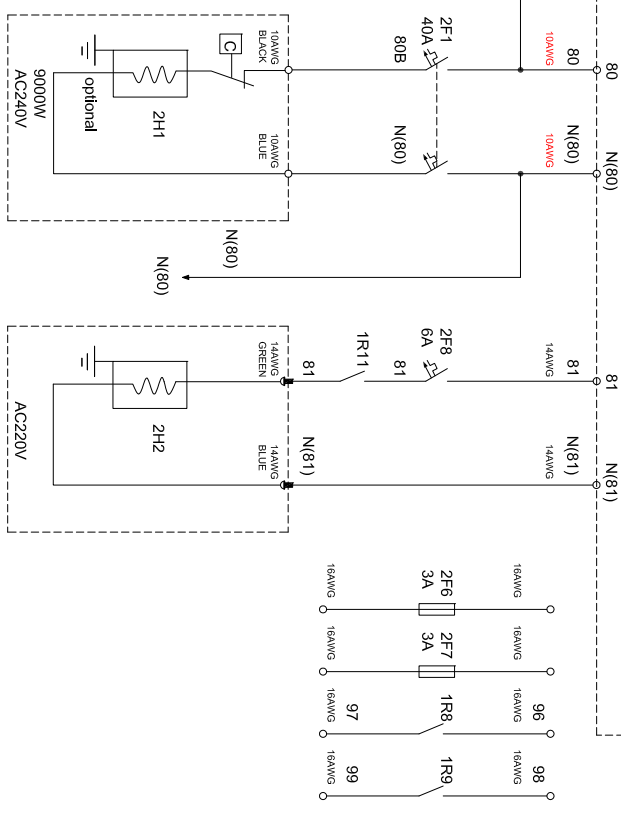

COPYRIGHT RESERVED ©

THE DESIGN AND DETAIL OF THIS DRAWING IS THE PROPERTY OF KESAL POWER GENERATION AND MUST BE RETURNED ON DEMAND. IT IS ISSUED ON THE STRICT CONDITION THAT WITHOUT WRITTEN PERMISSION IT MUST NOT BE REPRODUCED, COPIED OR COMMUNICATED TO ANY THIRD PARTY NOR BE USED FOR ANY PURPOSE OTHER THAN THAT STATED IN THE PARTICULAR ENQUIRY, ORDER OR CONTRACT WITH WHICH IT IS ISSUED. THE RESERVATION OF COPYRIGHT IN THIS DOCUMENT EXTENDS FROM EACH DATE APPEARING THERE ON AND IN RESPECT OF THE SUBJECT MATTERS AS IT APPEARED AT THE RELEVANT DATE.

ORDER CODE:	SCALE: 1:1	MATERIAL:	QUANTITY:	WEIGHT:
	2017	DATE	HELEN	SIGNATURE
	DESIGNED BY	02.05	HELEN	
	CHECKED BY	02.05	TONI	
	APPROVED BY	02.05	TOTO	
	DEPARTMENT:	ENGINEERING		
PART NO.:	SP-M2362084UL	USED FOR:	APP-DUM1000(M)SHADESH S12H DSE/320W/KIT WITH ANTI-CON/9KW WATER HEATER)	
DRAWING NO.:	SP-M2362084UL	LOCATION:	A4	
REVISION NO.:	01	PAGE	2-4	

COPYRIGHT RESERVED ©

THE DESIGN AND DETAIL OF THIS DRAWING IS THE PROPERTY OF KIKSAI POWER GENERATION. IT IS ISSUED ON THE STRICT CONDITION THAT WITHOUT WRITTEN PERMISSION IT MUST NOT BE REPRODUCED, COPIED OR COMMUNICATED TO ANY THIRD PARTY NOR BE USED FOR ANY PURPOSE OTHER THAN THAT STATED IN THE PARTICULAR ENQUIRY, ORDER OR CONTRACT WITH WHICH IT IS ISSUED. THE RESERVATION OF COPYRIGHT IN THIS DOCUMENT EXTENDS FROM EACH DATE APPEARING HERE ON AND IN RESPECT OF THE SUBJECT MATTERS AS IT APPEARED AT THE RELEVANT DATE.

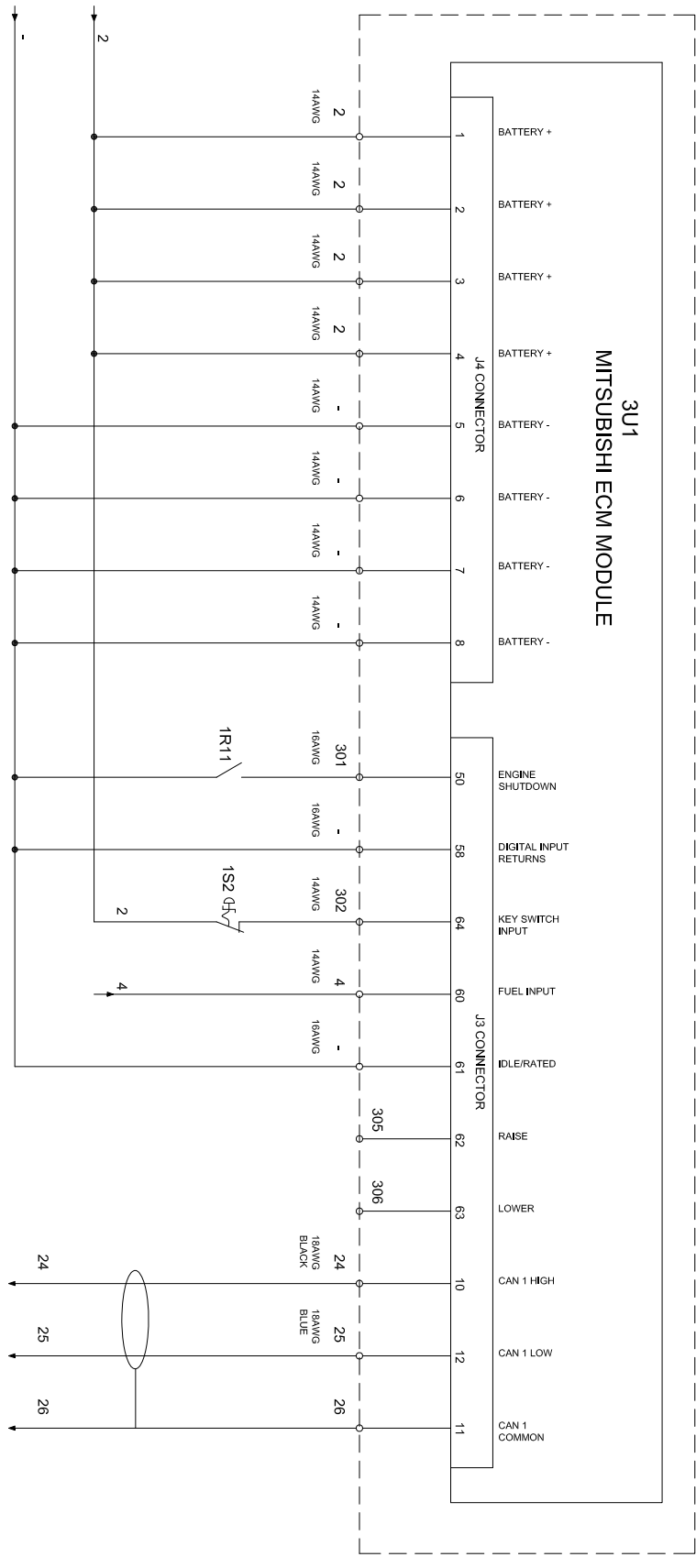

ORDER CODE:	SCALE: 1:1	MATERIAL:	QUANTITY:	WEIGHT:
	2017	DATE		
	HELEN	NAME		
	02/05	SIGNATURE		
	TON			
	02/05			
	TOTO			
DEPARTMENT: ENGINEERING				
PART NO.:	PART NAME:			
	START PANEL			
USED FOR:	ABD-UJLM1000(MITSUBISHI S12H			
	DSE/320W/KIT WITH AMT1-COM/9KW WATER HEATER)			
DRAWING NO.:	SP-MI2362084UL	LOCATION:		
REVISION NO.:	01	PAGE	A4	
		PAGE	3-4	

PE(16AWG Y/G)	<input type="radio"/>	<input type="radio"/>	<input checked="" type="radio"/>	<input type="radio"/>	<input type="radio"/>	PE
PE(16AWG Y/G)	<input type="radio"/>	<input type="radio"/>	PE	<input type="radio"/>	<input type="radio"/>	PE
PE(16AWG Y/G)	<input type="radio"/>	<input type="radio"/>	PE	<input type="radio"/>	<input type="radio"/>	PE
2(16AWG BLACK)	<input type="radio"/>	<input type="radio"/>	2	<input type="radio"/>	<input type="radio"/>	2
2(16AWG BLACK)	<input type="radio"/>	<input type="radio"/>	2	<input type="radio"/>	<input type="radio"/>	2
2(16AWG BLACK)	<input type="radio"/>	<input type="radio"/>	2	<input type="radio"/>	<input type="radio"/>	2
4(14AWG BLACK)	<input type="radio"/>	<input type="radio"/>	4	<input type="radio"/>	<input type="radio"/>	4
30(16AWG BLACK)	<input type="radio"/>	<input type="radio"/>	301	<input type="radio"/>	<input type="radio"/>	301
30(14AWG BLACK)	<input type="radio"/>	<input type="radio"/>	302	<input type="radio"/>	<input type="radio"/>	302
30(16AWG BLACK)	<input type="radio"/>	<input type="radio"/>	302	<input type="radio"/>	<input type="radio"/>	302
30(16AWG BLACK)	<input type="radio"/>	<input type="radio"/>	305	<input type="radio"/>	<input type="radio"/>	305
30(16AWG BLACK)	<input type="radio"/>	<input type="radio"/>	305	<input type="radio"/>	<input type="radio"/>	305
24(18AWG BLACK)	<input type="radio"/>	<input type="radio"/>	24	<input type="radio"/>	<input type="radio"/>	24
25(18AWG BLUE)	<input type="radio"/>	<input type="radio"/>	25	<input type="radio"/>	<input type="radio"/>	25
26(SHIELD)	<input type="radio"/>	<input type="radio"/>	26	<input type="radio"/>	<input type="radio"/>	26
80B(10AWG BLACK)	<input type="radio"/>	<input checked="" type="radio"/>	80B	<input type="radio"/>	<input type="radio"/>	80B
N(80)(10AWG BLUE)	<input type="radio"/>	<input type="radio"/>	N(80)	<input type="radio"/>	<input type="radio"/>	N(80)

COPYRIGHT RESERVED
 AND MUST BE RETURNED TO THE SUPPLIER. IT IS THE PROPERTY OF THE SUPPLIER AND IS NOT TO BE REPRODUCED OR TRANSMITTED IN ANY FORM OR BY ANY MEANS, ELECTRONIC OR MECHANICAL, INCLUDING PHOTOCOPYING, RECORDING, OR BY ANY INFORMATION STORAGE AND RETRIEVAL SYSTEM. THE SUPPLIER ASSUMES NO LIABILITY FOR THE CONTENTS OF THIS DOCUMENT. THE SUPPLIER ASSUMES NO LIABILITY FOR THE CONTENTS OF THIS DOCUMENT. THE SUPPLIER ASSUMES NO LIABILITY FOR THE CONTENTS OF THIS DOCUMENT. THE SUPPLIER ASSUMES NO LIABILITY FOR THE CONTENTS OF THIS DOCUMENT. THE SUPPLIER ASSUMES NO LIABILITY FOR THE CONTENTS OF THIS DOCUMENT.

PE(16AWG Y/G)	<input type="radio"/>	<input type="radio"/>	<input checked="" type="radio"/>	<input type="radio"/>	<input type="radio"/>	PE
PE(16AWG Y/G)	<input type="radio"/>	<input type="radio"/>	PE	<input type="radio"/>	<input type="radio"/>	PE
PE(16AWG Y/G)	<input type="radio"/>	<input type="radio"/>	PE	<input type="radio"/>	<input type="radio"/>	PE
48(16AWG BLACK)	<input type="radio"/>	<input type="radio"/>	48	<input type="radio"/>	<input type="radio"/>	48
2(16AWG BLACK)	<input type="radio"/>	<input type="radio"/>	2	<input type="radio"/>	<input type="radio"/>	2
2(16AWG BLACK)	<input type="radio"/>	<input type="radio"/>	2	<input type="radio"/>	<input type="radio"/>	2
33(16AWG BLACK)	<input type="radio"/>	<input type="radio"/>	33	<input type="radio"/>	<input type="radio"/>	33
03(16AWG BLACK)	<input type="radio"/>	<input type="radio"/>	03	<input type="radio"/>	<input type="radio"/>	03
3(16AWG BLACK)	<input type="radio"/>	<input type="radio"/>	3	<input type="radio"/>	<input type="radio"/>	3
80(10AWG BLACK)	<input type="radio"/>	<input type="radio"/>	80	<input type="radio"/>	<input type="radio"/>	80
N(80)(10AWG BLUE)	<input type="radio"/>	<input type="radio"/>	N(80)	<input type="radio"/>	<input type="radio"/>	N(80)
81(14AWG BLACK)	<input type="radio"/>	<input type="radio"/>	81	<input type="radio"/>	<input type="radio"/>	81
N(81)(14AWG BLUE)	<input type="radio"/>	<input type="radio"/>	N(81)	<input type="radio"/>	<input type="radio"/>	N(81)
82(14AWG BLACK)	<input type="radio"/>	<input type="radio"/>	82	<input type="radio"/>	<input type="radio"/>	82
N(82)(14AWG BLUE)	<input type="radio"/>	<input type="radio"/>	N(82)	<input type="radio"/>	<input type="radio"/>	N(82)
83(14AWG BLACK)	<input type="radio"/>	<input type="radio"/>	83	<input type="radio"/>	<input type="radio"/>	83
N(83)(14AWG BLUE)	<input type="radio"/>	<input type="radio"/>	N(83)	<input type="radio"/>	<input type="radio"/>	N(83)
84(14AWG BLACK)	<input type="radio"/>	<input type="radio"/>	84	<input type="radio"/>	<input type="radio"/>	84
N(84)(14AWG BLUE)	<input type="radio"/>	<input type="radio"/>	N(84)	<input type="radio"/>	<input type="radio"/>	N(84)
85(14AWG BLACK)	<input type="radio"/>	<input type="radio"/>	85	<input type="radio"/>	<input type="radio"/>	85
N(85)(14AWG BLUE)	<input type="radio"/>	<input type="radio"/>	N(85)	<input type="radio"/>	<input type="radio"/>	N(85)
86(14AWG BLACK)	<input type="radio"/>	<input type="radio"/>	86	<input type="radio"/>	<input type="radio"/>	86
10(16AWG BLACK)	<input type="radio"/>	<input type="radio"/>	10	<input type="radio"/>	<input type="radio"/>	10
94(16AWG BLACK)	<input type="radio"/>	<input type="radio"/>	94	<input type="radio"/>	<input type="radio"/>	94
95(16AWG BLACK)	<input type="radio"/>	<input type="radio"/>	95	<input type="radio"/>	<input type="radio"/>	95
96(16AWG BLACK)	<input type="radio"/>	<input type="radio"/>	96	<input type="radio"/>	<input type="radio"/>	96
97(16AWG BLACK)	<input type="radio"/>	<input type="radio"/>	97	<input type="radio"/>	<input type="radio"/>	97
98(16AWG BLACK)	<input type="radio"/>	<input type="radio"/>	98	<input type="radio"/>	<input type="radio"/>	98
99(16AWG BLACK)	<input type="radio"/>	<input type="radio"/>	99	<input type="radio"/>	<input type="radio"/>	99

24	2H1	WATER HEATER UL	UL 1977
23	2CT1	CURRENT TRANSFORMER UL	UL 1977
22	2T2	TYCO 4HOLE 1-480703-0	UL 1977
21	2T1	TYCO 9HOLE 1-480707-0	UL 1977
20	1T2	TYCO 6HOLE 1-480705-0	UL 1977
19	1T1	TYCO 15HOLE 1-480711-0	UL 1977
18	1F4,2F2,3F3,2F4	216002P/F2.0A 250V 5X20(FUSE)	UL 248
17	2F5,2F8	ABB S201U K6A-1P/HIGH BREAKER MINI CURRENT CIRCUIT	UL 489
16	2F1	ABB S202U K40A-2P/HIGH BREAKER MINI CURRENT CIRCUIT	UL 489
15	1F3	ABB S201U K16A-1P/HIGH BREAKER MINI CURRENT CIRCUIT	UL 489
14	1F2	ABB S201U K32A-1P/HIGH BREAKER MINI CURRENT CIRCUIT	UL 489
13	1F1	ABB S201U K6A-1P/HIGH BREAKER MINI CURRENT CIRCUIT	UL 489
12	2F6,2F7	2163.15P/F3.15A 250V 5X20(FUSE)	UL 248
11	1U2	DEEPSEA720MKII MODULE	UL 508
10	1U1	BATTERY CHARGE AC230V/DC24V	UL 1236
09	1L1	CANOPY LIGHT PD77WRR DC12V	UL 508
08	1S7	LOW WATER LEVEL SWITCH	
07	1S6	FLEXIBLE SENSOR	
06	1S5	WATER TEMP. SENSOR	
05	1S4	OIL PRESS SENSOR	
04	1S2	EMERGENCY STOP ABB UL	UL 94
03	1S1	CANOPY LIGHT SWITCH	
02	1R1, 1R2	ROCKWELL 700-4HHF6Z2A/SCHNEIDER 389F-XBCX1-24D DC24V 25A	UL 508
01	1R8, 1R9, 1R11	DRM270024LT(RELAY)AND RELAY N/C CONTACTOR	UL 508

- ⚠ : Canopy Genset do not install emergency stop 1S2 button in start panel. 1S21 is optional emergency stop.
- ⚠ : For all Aisa USA UL gensets are using two wire start off of digital input48 to start the genset up.
- ⚠ :1-6,01-06#Terminal model:Weidmuller ZDU 2.5/4AN UL(Ul 1059);7-9,12-29,08-014#Terminal model:Weidmuller ZDU2.5 UL(Ul 1059).
- ⚠ :10-11,015-016#Terminal model:Weidmuller ZDU10 UL(Ul 1059).

ITEM	PART NO.	ITEM DESCRIPTION	UL requirement
6			

ORDER CODE: _____ SCALE: 1:1 DRAWING NO.: SP-M2362084UL PART NO.: _____ USED FOR: APP-DLM1000(M)SHISHI S12H DSE/230V/KIT WITH AMT-COM/5KW WATER HEATER) LOCATION: _____ DRAWING NO.: _____ PART NO.: _____ USED FOR: _____ LOCATION: _____	MATERIAL: _____ QUANTITY: _____ WEIGHT: _____ START PANEL DEPARTMENT: ENGINEERING APPROVED BY: _____ DATE: 2017.02.05 NAME: HELEN SIGN: _____ VARIATION: _____ DATE: _____ NAME: _____
---	---